

# DX News

• Serving DX'ers since 1933 •

Volume 60, No. 26 - May 31, 1993 (ISSN 0737-1659)



## Inside ...

- 2 .. AM Switch
- 5 .. Now and Then
- 6 .. DDXD
- 16 .. IDXD
- 20 .. FMDXD
- 22 .. GYDXA-1490

- 26 .. Ernie Cooper
- 27 .. Sports Nets - Baseball
- 35 .. Geomagnetic Summary
- 37 .. NRD-525 Filter Leakage
- 41 .. Musings
- 47 .. NRC Convention

**From the Publisher ...** Congratulations to Col. Gene Paul Rust, Keller TX, on achieving 73 years of age and 61.5 years as a DX'er, since June, 1932!

Problems have occurred with obtaining verifications from WWJZ-640, Mount Holly, NY for their March 1 equipment test. DX'ers who heard the test are asked to send a copy of their report to Ron Musco - National Radio Club - P. O. Box 118 - Poquonock, CT 06064. Return postage is required. Ron will attempt to obtain verifications for the equipment test only.

Eric Bueneman - 631 Coachway Lane - Hazelwood, MO 63042 will be taking over the Bandscan column.

Check out the NRC Convention announcement on page 47 for Enfield '93 from Head Swatter Ron Musco, and then get your reservations in. Mr. Tact says that's an order, hi. Also check inside for more information on the WIFDA convention. And others not mentioned inside: The IRCA convention in Billings, MT June 25, 26, and 27 (send an SASE to John C. Johnson - 979 Neptune Blvd. - Billings, MT 59105-2129, and the *Monitoring Times* convention, October 15-17, in Atlanta (send an SASE to P. O. Box 98 - Brasstown, NC 28902 for information); and, from Walt Breville, information about the Midwest Radio Rama '93 June 25-6 near Cincinnati (SASE to Spark, Inc. - P. O. Box 658-WWB - Dayton, OH 45409; Extravaganza '93 July 16-18, Lansing MI (SASE: P. O. Box 585 - Okemos, MI 48864; and Radiofest, Aug. 4-7 (SASE: Jeff Aulik - 1708 Parkview - Rockford, IL 61107).

**DXChange ...** Former member Dave Schneider - Box 35-B, HC 1 - West Shokan, NY 12494 called to say that he is in the process of acquiring a number of RACAL RA6790/GM receivers and refurbishing them for resale, the first to go for about \$1,000, with NRC members getting first chance. You can also call him at (914) 657-6158 for more information. Dave says that this RACAL is about the best DX machine he has used. And Clifford Schnauffer - 444-1B Edgar Rd. - Elizabeth, NY 07202-3344 wants to buy a two-foot loop and an RF FET loop booster, new or used.

From DWM Enterprises - 1709 N. West Avenue, Suite 103 - Jackson, MI 49202, (517) 563-9022 comes announcement of their "Tiny-Tenna Active All-Band

Antenna for \$19.95. Larry Miller reviewed it in the April, 1993 *Monitoring Times*. DWM will send you a complete catalog of products for an SASE.

**Welcome to these new members ...** Richard Johnson, Springfield, VA; Trevor Goodwin, St. John's, Antigua, West Indies; James Wilson, Rochester, NY; Tony Decillis, Pembroke Pines, FL; Stan Shedd, Calgary, Alberta; Louis W. Ehrlich, Randallstown, MD; Chet Copeland, Washington, D. C.; Allen F. Mattis, Houston, TX; Jerry H. Neves KA6POZ; Patrick Mullen VE3ALN, Burlington, Ontario; Andrew Burns, Wysox, PA; and Tom McCue, Allison Park, PA. We stand at 686 members as of May 23.

The May, 1993 edition of the *Old Timers Bulletin* (for Antique Wireless Association members) listed as "silent keys" Joseph Horvath, Murray Shapiro, Joe Szabat W3LST, and Clive Taylor VE3CL. I believe that all have been NRC members at one time or another, if my memory serves correct. Our sincerest condolences to their families.

### Remaining DYN Schedule, Volume 60

#	Deadline/Pub. Date	#	Deadline/Pub. Date
27.	June 18 June 28	29.	Aug. 13 Aug. 23
28.	July 16 July 26	30.	Sept. 10 Sept. 20

### DX Time Machine

**From the pages of DX News:**

50 years ago ... from the May 19, 1943 DYN: Carroll Seth, Wellsville, NY sold his Hammarlund to the Navy for "a tidy sum". Al Bartholomew, Bradford, NY reported that of 39 reports sent during the past DX season, only XEQ, CMCH, HJCS, and WINC failed to verify, the first three probably because of war censorship.

25 years ago ... from the May 25, 1968 DYN: Several mentions were made of an article on NRC Supremacy Ratings (now IDXA) editor Norman L. Maguire in the May, 1968 CQ magazine.

10 years ago ... from the June 13, 1983 DYN: NRC dues were scheduled to go up from \$17 to \$19 for U. S. members ... Eric Bueneman took over the Bandscan column, listing scans from Mike Knitter, himself, and Guy Kudlemyer.

# AM Switch

**Jerry Starr**  
c/o WIIOT Radio  
4040 Simon Road  
Youngstown, OH 44512-1320

*Status changes in AM stations, supplied by the FCC and listeners*

## CALL LETTER CHANGES

Old call:	New call:	Old call:	New call:
620 KGW OR Portland	KINK	1260 WQZQ TN Dickson	WDKN*
640 WJTZ TN Blountville	WQXX	1310 WHFD PA Bedford	WAYC
740 WRPX WI Hudson	WMIN	1350 WBSK VA Portsmouth	WSVY
1010 KKGZ CO Brush	KSIR	1460 WPRW VA Manassas	WKDV*
1090 WQXX TN Kingsport	WKCV	1480 KFMJ NE Lincoln	KFMJ
1110 WWRX RI E. Providence	WHIM	1490 KJCN UT Ogden	KJCN
1230 KYZA CO Pueblo	KKP*	1520 WTVV KY Greenup	WLCC
1250 KKPX WA Seattle	KKDZ	1600 WAYC PA Bedford	WBFD

\*Notes: WDKN 1260 never used WQZQ, a call requested while the station was silent, they remain with WDKN. WPRW-1460 was first announced as changing to WKDZ, now seems to be asking for WKDV, or could be another FCC typo. We have a monitor almost in sight of their towers so we'll get the story straight as soon as they return to the air.

## APPLICATIONS FOR NEW STATIONS

1580 NJ Hackettstown: 2500 D3 (application for facility now licensed to silent WSRR Washington, NJ)  
1600 WA Blaine: 50000/5000 U4

## GRANTS FOR NEW STATIONS

None

## APPLICATIONS FROM EXISTING FACILITIES

550 WAYR FL Orange Park: add 260 watts at night  
830 WCRN MA Cherry Valley: city of license to Worcester, MA powers to 7000/5000  
980 KFVB CA Los Angeles: powers to 50000/50000  
KCTY CA Salinas: day power to 10000  
1130 KAAB AR Batesville: add 20 watts at night  
1190 WLIB NY New York: city of license to Yonkers (Why would they want to do this? See last issue for the story on the #1 criteria for moving to the expanded broadcast band, a city of over 100,000 population with no licensed stations. PRESTO! Yonkers is one of the very few cities meeting this parameter. We wonder who will be the first to notice that Jersey City, NJ also falls into this category?)  
1230 WXLI GA Dublin: reduce powers to 700/700  
1520 WXYB FL Indian Rocks Beach: reduce power to 600 watts, relocate transmitter site (station has been silent for more than several years, their old tower has been down for about as long)  
1540 WPCR PA Philadelphia: city of license to Bala Cynwyd, PA, add 500 watts at night, antenna to U4

## GRANTS TO EXISTING FACILITIES

550 WASG AL Atmore: day power to 25000  
640 WLJV FL Royal Palm Beach: changes in antenna system  
680 WCAW WV Charleston: reduce daytime power to 10000, relocate transmitter site  
850 KORC OR Waldport: add 10 watts at night



P.O. Box 1070, Sarnia, Ontario N7T 7K5

880 KKMC CA Gonzales: day power to 50000  
890 WQXR VA Fairlawn: relocate transmitter site (new station not yet on the air)  
930 KAGI OR Grants Pass: night power to 123 watts U1  
950 CHER NS Sydney: antenna to U2  
1030 KBUF KS Holcomb reduce day power to 1000 watts, antenna to U2  
1040 WJHR NJ Flemington: relocate transmitter site (new, not on the air yet)  
1150 WHBY WI Kimberly: construct auxiliary antenna  
1200 KOQI CA Soquel: powers to 50000/11000, relocate transmitter site (new, not on air yet)  
1230 WXLI GA Dublin: reduce powers to 700/700 (might set some sort of record for speedy FCC action, see 1230 Applications above)  
1280 KDYL UT Salt Lake City: powers to 10000/600 U4, relocate transmitter site  
1300 KDOV OR Phoenix: day power to 20000  
1340 WPBR FL Palm Beach: relocate transmitter site  
1450 KRZY NM Albuquerque: relocate transmitter site  
1460 KENO NV Las Vegas: day power to 30000 watts, relocate transmitter site  
1550 KQXI CO Arvada: relocate transmitter site  
1590 KXEM CA McFarland: to 750 kHz with 3000/600 U4, city of license to Bakersfield, CA.  
1600 KRVA TX Cockrell Hill: change synchronous transmitter from N1 to U1

## OTHERNESS

710 WKXB TN Smyrna: station is SILENT  
CHYR ON Leamington: new FM station (96.7) scheduled to begin broadcasting 8-1-93, at that time CHYR-AM on both 710 and 730 kHz will shut down for good.  
730 WJTO ME Bath: station now simulcasts programming from WLAM  
WVFN MI East Lansing: grant to add 500 watts at night has been rescinded by the FCC  
750 KMMJ NE Grand Island: after running at night for a short period of time, KMMJ has again returned to the daytime-only mode for which they are licensed, no word as to exactly what was going on  
800 WSMJ KY Cave City: license is CANCELLED, call DELETED  
850 WPFJ TN Fairview: station signs off at 5:00 PM (Central) year round, even in months when they are permitted to operate longer hours, per station.  
920 WTCW KY Whitesburg: silent due to fire, is ON THE AIR  
1010 WCNU FL Crestview: silent station has new owners and is expected to return to the air  
1080 WSSI MS Carthage: silent station is ON THE AIR  
1100 WLBB GA Carrollton: silent station is ON THE AIR  
1130 WAMG TN Gallatin: according to Ernie Ashworth (Grand Ole Opry performer and owner of this silent station) they plan to return to the air as soon as a new transmitter site can be found  
1160 WBND KY Florence: station is now here, ex-1180 kHz  
1170 WKFL FL Bushnell: silent station is ON THE AIR  
1190 WMAD WI Sun Prairie: silent station is ON THE AIR  
1220 WCPH TN Etowah: silent station is ON THE AIR (was back on for short time earlier this year, then went silent again)  
1230 KKPC CO Pueblo: silent station is ON THE AIR  
WWSO FL Quincy: station is SILENT

- 1240 KRAL WY Rawlings: station is SILENT  
 1250 WRKQ TN Madisonville: silent station is ON THE AIR  
 KKDZ WA Seattle: station is silent but their new calls (ex-KKFX) signal their return probably by the time this reaches you  
 1270 WYAK SC Surfside Beach: silent station is ON THE AIR (had been off for transmitter repairs)  
 1280 WSVE FL Jacksonville: station is SILENT  
 1290 WDEC GA Americus: station is SILENT, call to the station reveals the owners have no plans to return it to the air, transmitter has been donated to local college  
 1320 WWVT VT Randolph: if you've been hearing this station well at night, there's a reason, they were caught running their day power (1000 watts) at night (should be 66 watts) and the FCC fined them \$20,000  
 1340 KDEN CO Denver: station is SILENT  
 CFYK1 NWT Rae: this repeater of CHYK Yellowknife, NWT is SILENT (yes, that's right, we try to bring you ALL the BCB news!)
- 1360 WHLP MD Baltimore: station has already dropped their All Help Wanted format, is presently running a MOYL type format from a temporary studio in a garage (no fooling) and they are rumored to be ready to request a new call, WITH, as soon as the present WITH 1230 kHz changes to WKDH when they start their new Kids format
- 1370 KIMG CO Deer Trail: silent station is ON THE AIR  
 1380 WMTD WV Hinton: station is SILENT (according to MSJ they lost their transmitter site)  
 1400 WIXQ AL Andalusia: last issue we typo'd this call as "WIXO" in Otherness, they did not change calls  
 WGIN SC Georgetown: silent station is ON THE AIR  
 1410 WKKP GA McDonough: silent station is ON THE AIR  
 1440 WWLV FL Lehigh Acres: silent station is ON THE AIR  
 1450 WLYV IN Fort Wayne: station is SILENT  
 WCLM VA Highland Springs: station is SILENT  
 1470 WPCN NC Plymouth: station is SILENT  
 1480 KMEM NE Lincoln: silent station (ex-KFMQ) is scheduled to return to the air 6-1-93  
 1490 KXRE CO Manitou Springs: silent station is ON THE AIR and playing continuous Heavy Metal music without any announcements, even legal IDs, believed to be just testing prior to returning to regular programming  
 WZOR FL Immokalee: silent station is ON THE AIR  
 KBRO WA Bremerton: silent station is ON THE AIR  
 1500 WTNE TN Trenton: station is SILENT, towers fell in a storm in late 1992 but they say they plan to return to the air "this summer" and will be on 1500 kHz with 250 D3, their CP for 890 kHz is dead and gone, make this change in your Log  
 1530 KHAT NE Lincoln: station went SILENT at noon 4-30-93 and will not return, transmitter land was sold to a developer, owner can't justify the expense of relocating to another site  
 KCLR TX Ralls: silent station is ON THE AIR  
 1550 WLOR AL Huntsville: silent station is ON THE AIR  
 1560 WLJA GA Ellijay: silent station is ON THE AIR  
 1580 WWOF NC Camp Lejeune: station was silent, returned to the air for a few weeks, then again SILENT on 5-6-93

**KQTL**  
 24 HOUR SPANISH RADIO  
 1210 AM • 10,000 Watts

P.O. Box 1511  
 Tucson, Arizona 85702-1511

WDMF TN Knoxville: station is SILENT  
 1600 KQRO TX Cuero: station is SILENT  
 1660 ---- NV Las Vegas: If you live in the west and noticed any unusual activity on this frequency, USA Digital was using 1660 kHz for on-the-air demonstrations at the NAB convention in late April. In addition to digital audio they also ran normal analog signals on this frequency. In an article in R&R USA Digital claims this signal was received across "many western states" so we'd like to hear from any NRCers who may have stumbled across this test.

**WMT**

P.O. BOX 2147  
 660 OLD MARION ROAD, NE  
 CEDAR RAPIDS, IOWA 52406

**THANKS!!!!** Ron Musco, Al Merriman, Mike Hardester, Tom Bryant, Bill Hardy, Wayne Heinen, Bob McCoy, Gary Houdek, Dave Schmidt, Charles Harrison, MSJ and especially Steve Francis who generated much of the Silent/On the Air information above on an extensive tour of the south. All of Steve's information comes from direct monitoring and, in most cases, from visits to the stations.

WOW!! I can't remember the last time we had a four-pager, lots of stuff going on. Keep those cards and letters coming in, folks.

FLASH! Chuck Reh says that CHYR is now ND 24 hrs. on 710, no longer on 730.

73 and Good DX *Jerry & BKF* Jerry Starr & Buffalo K. Foonman

## Now and Then John D. Bowker

Dial changes in AM markets, from 1930 to 1948 to 1992

### MIAMI / FT LAUDERDALE MARKET (INCLUDES WEST PALM BEACH)

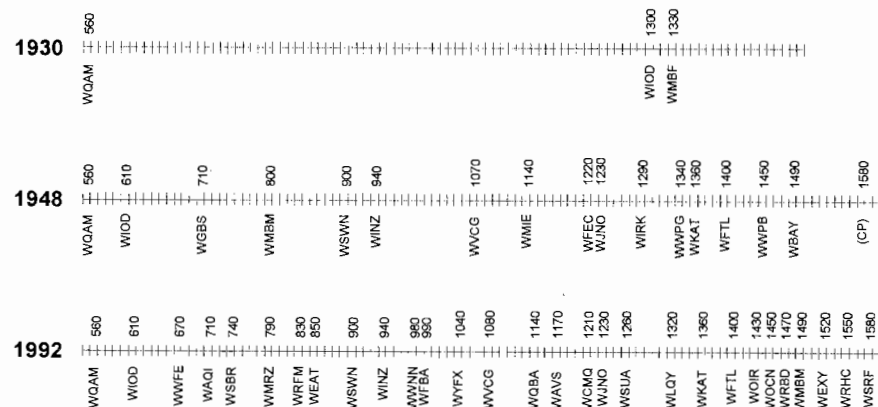

## For Beginners ...

the world of DX'ing can be confusing. And that's why Jack Woods' column, "For Beginners", was created. If you have a DX question, just mail it to Jack at P. O. Box 1003 - Waldport, OR 97394-0514, and he'll answer it in a future column. Remember - you're not alone - we all started at the beginning - once!

# Domestic DX Digest

North: Bill Hale

495 Creekview Drive - Meridian, ID 83642-3241

South: Duncan Shaw

2618 Ellendale Place, #3 - Los Angeles, CA 90007

East: Dave Braun

11 Mill Bend Acres - Wyoming, DE 19934-9523

*DX Catches in the U. S. and Canada, with 2-4-Br. ELT*



## DDXD-North

### MEDIUM WAVE RAMBLINGS



- Welcome aboard new reporters **Gary Moon** of Columbus, Ohio, **Bart Cronin** from Edmonds, Washington and **Frank Aden** of Boise, Idaho! Glad to have you guys in our DX family. Report more, and often. Gary mentions he's looking for an R-390A in mint condition. Got one? Write to him at 2668 Halstock Ct, Columbus, OH 43235.
- Thanks to a tip from **John Johnson** (CDXR editor for IRCA) to try for it, I was able to log the experimental Digital Audio Demonstration station from Las Vegas on 1660. We editors have to stick together, you know. Details in SPECIAL, along with another tip from John. And the mailbox also produced results from others who heard this test, plus a new Grove catalog!
- Another plea from the editor . . . PLEASE, put your loggings in frequency order broken into the categories seen here. That means 610 before 950, before 1430, before 1510, etc, etc, etc. Sorry to have to harp on this same subject over and over, but some reporters, as in the words of a campaigning politician, . . . *just don't get it.*
- Here are the remaining deadlines for DDXD-N for Volume 60, which in one of these issues (the real, hi) Graveyard Totals will appear. ☑ yours in pronto!
 

Issue 27	Jun 12	Issue 29	Aug 7
Issue 28	Jul 10	Issue 30	Sep 4

CUN June!

### REALLY SPECIAL



P.O. Box 1770  
Aberdeen, SD 57402-1770

- 1660 **KDAB** **NV Las Vegas - 4/18 0730** - Digital test in conjunction with the NAB Convention run by **USA Digital Radio**. Signal is S-5 or S-6. Playing oldies and some POP. Announcements between songs refer to manufacturers and suppliers of digital products and their booth numbers at the convention. Announced they are using facilities of KENO-1460 and test was also on 97.1 FM. No experimental CLs heard. 1st logging in expanded band. Wish I could pick it up in digital. (BC-WA)
- KDAB** **NV Las Vegas - 4/18 2330** - Running light ROK (old & new) + some C&W. Several announcements for sponsors of DAB plus their booth numbers. Report (tape) sent to KENO asking them to forward to proper individuals. (FA-ID)
- KDAB** **NV Las Vegas - 4/18-20 all night to 0830 fadeout** - Demonstration station put on by **USA Digital Radio** at NAB Convention. Fair signal (4-7 dots) on the -2010, then fairly good in car going to work. No \$ noted. Programming consisted of plugs for the system, with announcements for participating companies and their convention booth numbers between primarily oldies, with some C&W thrown in. No idea as to power or other radiation data. Gone by Thursday 4/22. Maybe one of our members who is in the industry and was in attendance will fill in the many blanks. [Ed.-ID]

### ORDINARY SPECIAL

- 1140 **KXNO** **NV North Las Vegas - Now using this call and Casino Radio slogan.** Can best be described as a TIS for Vegas. Also heard: *Give us 20 minutes and we'll give you Las Vegas.* Back-to-back segments on Vegas and area events. Also headliners at various casinos. ID *Casino Radio is KXNO North Las Vegas.* 1140. *Casino Radio.* (JJ-MT)
- 1240 **KMAY** **MT Billings - As per CL change to this in last AM Switch,** they are IDing as *KUUS is KMAY Billings.* Station was bought by a local broadcast school, **May Technical College.** (JJ-MT) [No telling what you'll there, now, hi - Ed.]
- 1330 **WFIN** **OH Findlay - Drops Stereo** after six years. (JL-OH)
- 1430 **WFOB** **OH Fostoria - Added Stereo** just recently and now IDs as *AM Stereo 1430, WFOB Fostoria - Bowling Green.* (JL-OH)
- 1600 **WBFD** **PA Bedford - 4/15 1930** - Fair in CHNR null with *Take Pride in America* PSA, program anncts, ID as *1600 WBFD Bedford, Pennsylvania* ⇒ GOS music. A call to WAYC, the Bedford station listed on the channel, cleared up the mystery. Apparently, **WAYC and WBFD swapped frequencies** about 4/8. **WAYC is now on 1310.** (MS-ON)



### UNIDs and UNID HELP

- 1370 **KCCO?** ?? - 4/23 0757-0801 - Out of a C&W tune into *We're glad you're here, KCCO Springfield* ⇒ CBS News and fadeout. Can't match CLs, city or nuttin'. May have been an FM ID. KPCO, maybe. But *Springfield??* Help! [Ed.-ID\*]

### DX AND EQUIPMENT TESTS

- 1330 **WVHI** **IN Evansville - 4/19 0119** - Good with VID at 0119, TT at 0120, 0124, 0127, 0130. Under KNOW. New. (SA-MB) [Shawn, this is correct state - Ed.]
- WVHI** **IN Evansville - 4/19 0100-0200** - Started weak under WFBC, with TTs of varying pitch from 0107 to 0118, then a power boost allowed them to dominate the frequency. VID and a test announcement ⇒ varying TTs ⇒ VID with announcement at 0148 that they would continue the test for another 30 to 60 minutes ⇒ eclectic mix of BBD, C&W and GOS music. (JL-OH)
- WVHI** **IN Evansville - 4/19 0118-0200** - Fair over pest WEYZ with DX Test. Noted variety of TTs, then ID at 0148: *This is WVHI Evansville, Indiana at 1330 on the AM dial, serving the entire tri-state area, making special frequency response and programming tests at this time* ⇒ an instrumental version of *When The Saints Go Marching In*. Other IDs noted at 0152 and 0156 followed by various MoR tunes. (MB-ON)

### MIDNIGHT TO 0800 HOURS ELT

- 590 **KAQQ** **WA Spokane - 4/25 0650** - Good with NOS music and *KAQQ Spokane* ID. (SA-DX)
- 630 **WLAP** **KY Lexington - 4/20 0015** - Fair with *National Town Forum*. Ad for *Gunweek.* (TR-IL)
- 640 **KFI** **CA Los Angeles - 4/25 0620** - Good with talk program. Lots of *KFI* IDs. In CKRC splatter. (SA-DX)
- 670 **KBOI** **ID Boise - 4/25 0655** - Clear with oldies, in CJOB splatter + *WMAQ.* (SA-DX)
- 740 **CHCM** **NF Marystown - 4/4 0312** - Poor with CBL off. Heard rundown of NHL scores on *Newfoundland's sports authority, VOCM* ⇒ *Don McLean's American Pie* and other oldie standards | *VOCM-590.* Heard in 1984 as CBNM with CBS programming. (MB-ON)
- 760 **WJR** **MI Detroit - 4/20 0010** - Fair with talk about the Waco cult standoff aftermath on *ABC Nightline.* (TR-IL)
- 770 **WABC** **NY New York - 4/20 0007** - Fair in *WBBM* splash with ad for *Amoco Ultimate.* *Yankees vs A's* MLB. (TR-IL)

- 8 810 WGY NY Schenectady - 4/20 0005 - Fair with *Dr. Joy Brown is here to help on Radio 810, WGY.* (TR-IL)
- 900 KBIF CA Fresno - 5/11 0745-0803 - Running Sports Entertainment Network feed | KVEG/others. Unistar News at 0800 after *KBIF Fresno ID.* Change from SS as in Log. First-timer. [Ed.-ID\*]
- 1060 WHFB MI Benton Harbor - 4/3 0615 - Fair with NOS/BBD music. *Central Coast Original Hits Station, AM 1060 WHFB. It's 20 minutes after 6 O'Clock.* New. (SA-MB)
- 1180 WLDS IL Jacksonville - 4/4 0704 - Fair with 1180 Radio WLDS weather into EZL music + now CBS News. (SA-MB)
- 1220 WKNR OH Cleveland - 4/18 0102 - Fair to poor with CBS News, *WKNR Color Radar Weather*, and *Sports Radio 1220 WKNR ID.* *Insomniac Sports Show.* (TR-IL)
- 1250 KHOT CA Madera - 5/5 0557 - Fair with SS music and talking. ID with two place names, the second being *Fresno.* After hearing to ID several times am not sure of the first. It may be *Madera.* KKFY Seattle off. (JW-OR)
- KTMS CA Santa Barbara - 5/2 0655-0700 - Poor under SS music with SS music, ID, Santa Barbara ads and into CNN News. First-timer. (JW-OR)
- 1260 WIBV IL Belleville - 4/18 0057 - Fair to very poor with call-in show re Rodney King verdict on MBS. *You're listening to Hot Talk WIBV Belleville-St. Louis ID.* MBS News. Infrequent logging. (TR-IL)
- 1320 WJAS PA Pittsburgh - 4/18 0050 - With Music of Your Life, 1320 WJAS ID. Infrequent logging. (TR-IL)
- 1330 KWLO IA Waterloo - 4/19 0100 - Very poor with CL ID, under KNOW while waiting for the WVHI test. New. (SA-MB)
- 1380 WMPS TN Millington - 4/6 0650 - Poor with GOS music, CL ID. In a mess. New. (SA-MB)

# WGKA

P.O. BOX 52128  
ATLANTA, GEORGIA 30355

## 0800 TO 1600 HOURS ELT

- 700 KFAM UT North Salt Lake City - 5/1 1600 - With MoYL format. Excellent signal. First daylight reception. (FA-ID)
- 940 WMIX IL Mount Vernon - 4/13 0830 - Poor with WJPC splash with state and local weather, Mount Vernon temperature. New. (TR-IL)
- 1060 KBGN ID Caldwell - 5/6 0922-0930 - Good with contemporary religious music, ID at :30 => talk about being a good listener. First time heard. (JW-OR)
- 1080 KSCO CA Santa Cruz - 5/6 0935 - Fair to poor under KWJJ Portland with ID, promo for local hospital, request for blood donations. (JW-OR)
- 1120 KMOX MO St. Louis - 4/13 0917 - Good signal with *KMOX Sports*, ad for *Mirex Copy Company*, a tribute to Missouri Nurses, traffic report. (TR-IL)
- 1130 WISN WI Milwaukee - 4/13 0930 - With traffic report, weather, story on positive programs for blacks in Milwaukee, update on water crisis. (TR-IL)
- 1420 KUJ WA Walla Walla - 5/15 0857-0900:10 - Poor with end of *Grazin' In The Grass* by *Friends of Distinction*, quick *Your oldies station, KUJ* (no city heard) => unID network news (may have been Ac). New. [Ed.-ID]
- 1530 WCKY OH Cincinnati - 4/13 0913 - Fair with *Newstalk WCKY ID.* (TR-IL)

## 1600 TO 2400 HOURS ELT

- 790 WPIC PA Sharon - 4/15 2023 - Fair with PSA mentioning *WPIC asks you to help.* Promos for various programs on 790 WPIC. (MS-ON)
- 800 CKLW ON Windsor - 4/19 2118 - Fair to poor with call-in show about *Are you getting enough sex?* (TR-IL)
- 830 WCCO MN Minneapolis - 4/19 2121 - Good with *Twins vs Brewers MLB.* (TR-IL)
- 850 KOA CO Denver - 4/19 2133 - Poor with *Rockies vs Cardinals MLB.* (TR-IL)
- 900 CHML ON Hamilton - 4/19 2137 - Poor in WLS splash with *KC Royals vs Blue Jays MLB.* (TR-IL)
- 920 CFRY MB Portage la Prairie - 4/24 2247 - Excellent with polka, C&W, old-tyme fiddle music. (SA-DX)
- 990 CBW MB Winnipeg - 4/19 2145 - Poor in WLUP splash with discussion about publisher's and their editorial policies for the comics. (TR-IL)
- 1030 KBUF KS Holcomb - 4/14 2055 - Good with several *KBUF IDs* during *Colorado Rockies* baseball. (SA-MB)

- 1050 WDWZ IL Decatur - 4/19 2153 - Poor with *Houston Astros vs Chicago Cubs* MLB. (TR-IL)
- 1110 WKRA MS Holly Springs - 4/24 2005 - Poor with local ads, *WKRA ID.* In brief fade-up under KFAB. New. (SA-DX)
- 1120 KMOX MO St. Louis - 4/19 2110 - Poor with *Cardinals vs Rockies* MLB. (TR-IL)
- 1140 WRVA VA Richmond - 4/19 2157 - Fair with talk about the sale of a racing team and NASCAR racing on Motor Racing Net. (TR-IL)
- 1180 WHAM NY Rochester - 4/19 2159 - Fair with *WHAM. Rochester's News Leader* => CBS News. (TR-IL)
- 1250 WEMP WI Milwaukee - 4/19 2250 - Fair with ID. (GM-OH)
- CHWO ON Oakville - 4/19 2301 - Fading signal + static. Broadcast News, then sports. (GM-OH)
- 1330 WFBC SC Greenville - 4/13 2222-2241 - Tail-end of *Braves vs Cubs* on *Braves* Network. Local ads including ones for *B-R's Hamburgers* and *Parker Hardware.* (GM-OH)
- WHBL WI Sheboygan - 4/24 1940 - Good w/NOS music & *WHBL ID.* (SA-DX)
- 1370 WSPD OH Toledo - 4/19 2211 - Fair with ad for *SportsChannel* and *Cleveland Cavaliers.* (TR-IL)
- 1440 KKXL ND Grand Forks - 4/24 1933 - Good with *April 19th Country in the Morning* program with *Double K Country* IDs, weather. Somebody realized boo-boo after three minutes and back to DJ. (SA-DX)
- 1510 KJLA MO Independence - 4/13 2050 - Fair with NOS music and *You're tuned to* ? radio station for *great music, 1510 KJLA.* Sign-off at 2059. New phone number 816-254-1073. Ex. KIDZ. (SA-MB)
- 1530 WCKY OH Cincinnati - 4/19 2207 - Fair with *Gil Gross Show* and talk about the *Hame Alone* couple. (TR-IL)
- 1550 CBE ON Windsor - 4/19 2205 - Poor with CBC Sports. (TR-IL)
- 1580 WRDD PA Ebersburg - 4/16 2000 - Good with dual sign-off for WRDD-1580 and WNCC-950 mentioning 1000 watts for the former and 500 watts for the latter. *The best in Christian programming.* (MS-ON)
- 1590 KCNN MN East Grand Forks - 4/13 2102 - Excellent with re-broadcast of *CJOB's Winnipeg Jets Hockey.* About a one-second delay behind, and running different ads than, *CJOB.* (SA-MB)
- 1600 WBBD WV Wheeling - 4/15 2005 - Fair in CHNR null with ID mentioning . . . *hits of the 40s, 50, and 60s on AM 1600 WBBD.* (MS-ON)

## REPORTERS

- BC-WA Bart Cronin Edmonds, WA; HQ-160
- GM-OH Gary Moon Columbus, OH; Sony ICF-2010
- TR-IL Thomas Reiser Chicago, IL; Sony ICF-2003 (x3)
- JJ-MT John Johnson Billings, MT; via Prodigy
- SA-MB Shawn Axelrod Winnipeg, MB; ICOM R-70 + 4' box loop or 100' lw
- MB-DX Manitoba DXpedition (Shawn Axelrod) Valhalla Beach DX Site, MB; ICOM R-70 on about 500' south and west beverages
- JL-OH Jeffrey Less Toledo, OH; Panasonic RF-5000A, TM-152
- MB-ON Mike Brooker Toronto, ON; Panasonic RF-2200 or Sony ICF-7600D
- MS-ON Morris Sorensen Scarborough, ON; GE Superadio II "barefoot"
- JW-OR Jack Woods Waldport, OR; ICF-2010, Martens loop, Palomar loop
- FA-ID Frank Aden Boise, ID; Modified FRG-7 + MW-1
- Ed.-ID Editor Meridian, ID; Sony ICF-2010 barefoot\* and Delco AM\$/FM\$ caradio

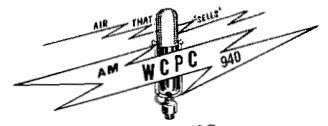

Rt. 2, Box 10C  
Houston, MS 38851

## ABBREVIATIONS AND SPECIAL SYMBOLS USED IN DDXD - North

||:parallel with/to => :to or into :00:on the hour AC:Adult contemporary AP:Associated Press BBD:big band BRN:Business Radio Net C&W:country & western CCR:contemporary Christian radio CHR:contemporary hit radio CID:code ID CL:call letter EZL:easy listening EE:English FF:French GOS:gospel IRN:Interstate Radio Net LSR:local sunrise LSS:local sunset MLB:Major League Baseball NBA:National Basketball Assn NHL:National Hockey League NPR:National Public Radio OC:open carrier POL:political PSRA:pre-sunrise authority PSSA:post-sunset authority QRM:man-made interference QRN:natural interference QTH:location REL:religious ROK:rock 'n' roll RS:regular schedule \$:store SID:singing ID SRS:sunrise skip SS:Spanish SSB:Star Spangled Banner SSS:sunset skip TC:time check TT:test tones UC:urban contemporary UPI:United Press International

73, Bill



## DDXD-East NEWS AND VIEWS

This issue Shawn Axelrod crosses the border to help with a recent UNID, and Alan Millmuker also comes to DDXD-East land to help with an UNID.

Laurence Kearley sent along the results of three hours of DXing from Halifax, Nova Scotia which I have compiled into one bandscan at the end of the column.

Bob Gilfert mentions that their baby has been sleeping better than expected, so he has had no late night DX feasts as was expected. Bob also called on 5/14 with a **Special** item on WPRW. Read on for details.

And a big welcome to first time reporter Walter Windish from Wayne, New Jersey. Hope to hear from you often!

In addition to the UNIDs listed below, I have been hearing NY Yankees baseball on 1340 and 1400, can anyone help with these? The Yankees were also heard on WEOK-1390.

Upcoming deadlines through the summer are June 12, July 10, August 7 and September 4. Remember to check your locals during the summer months and report any changes to the appropriate NRC column!

### SPECIAL

- 900 WBGG** NY Saratoga Springs - 4/25 0600 - With ID as WBUG Amsterdam, ?? FM, and WBGG Saratoga Springs, The Bug" and into a CW song *Guitars and Cadillacs*. It was fighting a losing battle with CHML and others which is not surprising as it's listed as 200 watts with a PSRA of 70 watts. (LK-ON)
- 1110 WHIM** RI East Providence - 5/8 2110 - Good with CW music, WHIM IDs, and RI lottery numbers. Ex-WWRX "1110-CNN". (BC-NH)
- 1460 WCMB** PA Harrisburg - 5/9 0100 - Noted with change back to old calls, ex-WIMX. (DB-DE)
- WPRW** VA Manassas - 4/20 - Is indeed still silent, however 5 or 6 months ago they were on one evening for an hour or so playing CW music. Drying out transmitter I guess. It's possible they were on again 3/22 as reported by IM-NY in DXN 60-24. The evening I heard them it was around 1930. (AM-VA)
- WKDZ?** VA Manassas - 5/14 Noted back on the air with kids format, fighting WOL slop. No ID heard. (BG-DC)
- 1470 WWWW?** OH Toledo - 5/6 2157 - Heard PSA for learn to read program sponsored by the State of Ohio and then an ID as "Toledo's new magic 1470." In very briefly under CHOW and others. (JB-MA)
- 1480 WSAR** MA Fall River - 5/1 2009 - Playing oldies music and then an ID as "WHTB Home Town Bill" and mentioned using 1400 and 1480. I tuned to 1400 and sure enough the same guy was there too. (JB-MA)
- 1590 WEEB** NC Southern Pines(?) - 4/26 0059 - Heard with station ID, affiliated stations mentioned. ID as "Newstalk radio, WEEB, 1590, covering central Carolina." #17 heard from NC. (LGW-NC) (Can anyone tell us which NC station this is? - db)

### DX TESTS

- 1280 WCPM** KY Cumberland - 4/1 - Thought it was an April Fools gag and slept through it. (BG-DC)
- 1330 WVHI** IN Evansville - 4/19 0315-0400 - Not heard. (BG-DC)

**KLOK AM 1170**  
*Radio Kleg*

### UNID AND UNID HELP

- 690 CBKF1** SK Gravelbourg - JEK-MD's UNID has to be this if he got FF over CBF as these are the only two FF Canadian stations on 690. CBKF1 is a big pest here when you can null CJOB-680 so they have a south and east lobe of some sort. They are sometimes especially late night //CKSB-1050. If JEK still has a tape I'd give a listen for him. My French isn't perfect but... (SA-MB)
- 870 UNID** 4/24 0706 - Under WLAM with SS talk then what sounded like SS polka music, if there is such a thing. Loop was WSW/ENE. Under WHCU. (LK-ON)
- 880 UNID** 5/11 0100+ - CW music barely audible under WCBS for several hours. Gave up trying for an ID at 0430. DF was NE/SW. (BG-DC)
- 890 UNID** 4/24 0712 - In WLS null (I've never heard even the slightest thing here except for WLS) with a religious song, a very long one called "God is Good" which sounded like part of a concert due to background noise and talk. Very weak with total fade by 0725. (LK-ON)

- 910 UNID** 4/28 2120 - Red Barons baseball on the "Red Barons baseball network." Commercial ads for *Thrift Auto Body*, *Insurance Brokers of ?* and a Recycling company. (JB-MA) (Probably WGBI, Scranton's AAA team is the Red Barons - db)
- 910 UNID** 4/28 2200 - Baltimore vs. Minnesota baseball game. Believe it was an Orioles network station. (JB-MA) (WSBA-York, PA - db)
- 940 WMIX** IL Mount Vernon - Bob Gilfert's UNID in the May 3 issue is most likely WMIX. They carry St. Louis Blues and St. Louis Cardinals. Their antenna pattern of the night time site goes to the east. I used to be an assistant engineer of the night time site when it came on the air. I was also a DJ at WMIX until the 1980's. My dad is part time engineer there now. (AM-IL)
- 1010 UNID** 5/10 0546 - Someone with SEN sports //WLKW-960. (DB-DE)
- 1260 UNID** 5/15 2347 - FF talk heard herein a mess with WWDC and a couple of others. (DB-DE)
- 1300 UNID** 4/7 2030 - Call in program with "The Greaseman" as the host. (JB-MA) (WJFK-MD on the same net, I think, as Howard Stern - db)
- 1300 UNID** 5/6 2028 - *Metallica* tune briefly up over WJFK, gone by 2031. In car so no DF. WQPM? (BG-DC)
- 1420 UNID** 4/23 0105 - Tentative sign off with SSB. Several candidates. Anyone know who plays SSB at sign off? (BG-DC)

**KFQD 750 AM**

**KWHL 106.5**

**0000 to 0800 ELT**

- 600 WMT** IA Cedar Rapids - 4/24 0528 - With "coming up right here on 600, WMT" and an ad for a game called "Uh, Oh" followed by the weather and a further ID. In null of WICC with no CIQC in sight. (LK-ON)
- 670 WWFE** FL Miami - 4/21 0527+ - Good, possibly news in Spanish with mentions of David Koresh, Waco, Texas and CNN. "Radio Fe" IDs at 0527 and 0529. (BG-DC)
- 720 CHTN** PI Charlotetown - 5/8 0247 - Poor under WGN with oldies. First time heard since move to DC. (BG-DC)
- 760 WVNE** MA Leicester - 4/24 0600 - With USA network news then call ID and weather and a religious song. In null of WJR. (LK-ON)
- 820 WIQT** NY Horseheads - 4/24 0615 - With "the QT countdown" of CW music in the null of CHAM. Call, Unistar network and city ID at 0657. Severe fade. (LK-ON)
- WNYC** NY New York - 4/24 0629 - While checking out the above, got a brief fade-up with ID of "WNYC" and "This is NPR, National Public Radio" then complete fade. In null of CHAM. (LK-ON)
- 830 CFJR** ON Brockville - 4/18 0200 - Heard with end of CBC news and "Coast to Coast" ID. (LGW-NY)
- 870 WHCU** NY Ithaca - 4/24 0706 - With ID as "News Radio" which sounds like a format change. (LK-ON)
- 900 CHML** ON Hamilton - 5/1 0000 - Classic rock, news, sports, "Classic Oldies 900 CHML." (WW-NJ)
- 910 WNEZ** CT New Britain - 4/25 0019 - ID over mess into CNN sports, probably also the one heard earlier with CNN Headline News. (DB-DE)
- 940 WINZ** FL Miami - 4/7 0030 - In with local weathercast, under CBM. (LGW-NY)
- WMIX** IL Mt. Vernon - 4/26 0230 - Promo for *Larry King Show* weekdays on "AM 940 WMIX", into *Jim Bohannon Show*. (ES-NJ)
- 990 WRMM** NY Rochester - 5/1 0032 - Rock music, commercials for *Classic Cat Tavern* and a Tuxedo shop, interference from CKIS. (WW-NJ)
- CKIS** PQ Montreal - 4/11 0300 - Heard with rock music. IDs after each song, over and under WZZD. (LGW-NY)
- CKIS** PQ Montreal - 5/1 0026 - "Oldies 990 KIS, Montreal", PSA for *AIDS Saturday* on May 15. (WW-NJ)
- 1000 CKBW** NS Bridgewater - 4/11 0235 - In all alone with local weathercast. Good clear signal. Nice bet for Nova Scotia. (LGW-NY)
- 1150 WHUN** PA Huntingdon - 4/26 0245 - With CW music, "WHUN, great songs from the past and today's hot new country", AN now? (ES-NJ)
- 1180 WHAM** NY Rochester - 4/26 0200-0300+ - Noted with OC and TT. (ES-NJ)
- 1220 WKMT** NC Kings Mountain - 5/10 0525 - CW music on top of frequency, local announcer with ID, on 500 watt PSRA? (DB-DE)
- WJUN** PA Mexico - 5/3 0605 - End of the news and then the "Radio Pennsylvania weather forecast." Also on 5/4 at 0615, end of a Beach Boys song and "It's always better at WJUN." Fair in a jumble of others. New here. (JB-MA)

- 1250 WTAE PA Pittsburgh - 4/21 0125+ - Poor under UNID NOS, call letter ID and into UNID news at 0130. (BG-DC)
- 1280 WKST PA New Castle - 5/1 0755 - News then PSA "brought to you by the Drug Free Partnership of Pennsylvania", ID. (DB-DE)
- CJMS PQ Montreal - 5/12 0444+ - Lots of fades but excellent on peaks. EE and FF music, FF talk about baseball, call letter sung ID at 0500 and into FF news. (BG-DC)
- 1290 WNLB VA Rocky Mount - 5/1 0720 - Over a talk station in WJBR null with "Solid Gospel WNLB". (DB-DE)
- 1300 WKCY VA Harrisonburg - 5/5 0613-0619 - Station promotion with local restaurant, WKCY mentioned 4-5 times and then into CW music. Mostly over WJFK and new here. (JB-MA)
- 1310 WSLW WV White Sulphur Springs - 5/1 0748 - Marvin Gaye oldie, ad for Jeep dealer in Lewisburg, ID, DJ mentioned weather coming up "brought to you by the Bank of ? in White Sulphur Springs". (DB-DE)
- 1330 WEBO NY Owego - 4/27 0615 - Heard playing CW music and several mentions of Owego and Binghamton with 2-3 IDs. In quite well at times. New here. (JB-MA)
- 1350 WNVA VA Norton - 5/1 0706 - Good with mention of ? County then ID. (DB-DE)
- 1420 WHK OH Cleveland - 4/21 Poor with "WHK Cleveland forecast". (BG-DC)
- WCED PA Dubois - 4/23 0039 - Poor to good with 60's and 70's rock. ABC news at 0100. (BG-DC)
- 1450 WWSC NY Glens Falls - 4/25 0054 - Heard Oldies songs on top of the channel from 0025, finally at this time heard ID into Mamas & Papas song, local announcer. (DB-DE)
- 1460 WBKC OH Painesville - 4/27 0606 - End of news, then weather and ID and into OLD/NOS song. Over/under CKRB and WCMB but was quite loud at 0613. New here. (JB-MA)
- 1470 WXKW PA Allentown - 4/27 0030 - CW music, hard to pull out of slop, best heard on 1467. (WW-NJ)
- 1520 WWKB NY Buffalo - 4/24 0448 - With music and talk in SS with an ID of "Radio Christiana Culturelles", then an address for the *Song of Life* program in Brooklyn, New York. The mystery was solved at 0500 with an EE ID as "WWKB, Buffalo" and back to SS music. (LK-ON)
- 1550 WCLY NC Raleigh - 4/19 0230 - Nice signal with gospel music. (LGW-NY)
- WCLY NC Raleigh - 4/26 0315 - With gospel music, ads, ID. Becoming a MM pest here. Definitely running 1 kw, no way 7 watts. Permanent power increase? Hope not. (ES-NJ)
- 1560 WPAD KY Paducah - 4/19 0232 - Heard with ID and mentioning of hits played. Only #3 from KY heard here. (LGW-NY)
- 1580 WPGC MD Morningside - 4/9 0045 - In with talk show and local weather. (LGW-NY)
- WZKY NC Albemarle - 4/11 0030 - In with ID. Nice signal. (LGW-NY)

**0800 to 1600 ELT****KERR-750<sup>AM</sup>**

- 1450 WKRI RI West Warwick - 5/7 1520 - Noted in Spanish with "Super K" IDs and ads for South Providence hispanic community businesses. (BC-NH)

**1600 TO 2400 ELT**

- 540 WGTOT FL Pine Hills - 5/11 2337 - Poor under CJSB with much talk about Florida Marlins baseball. Does WGTOT carry the Marlins? (BG-DC)
- 620 WHEN NY Syracuse - 4/11 2302 - Call letter ID, *ESPN Network* ID and into UNID news. Lost to mess and WMAL slop by 2305. (BG-DC)
- 700 CHSJ NB St. John - 4/28 1930 - "All country all the time on CHSJ Country 700", call taken on request line, 1945:15 pattern and power shift. (ES-NJ)
- 730 WFMC NC Goldsboro - 5/2 2153 - Promotion for station contest with mentions of sponsors, gift certificates and lots of WFMC IDs. Also mentioned "AM Stereo 73 WFMC" and "Your variety country". Over/under CKAC and new here. (JB-MA)
- 740 WVCH PA Chester - 4/17 1945 - Heard with sign off mentioning "WVCH concludes 1,660th day of broadcast." (LGW-NY) (I wonder if Dave Schmidt did the math for them? - db)
- 780 WABS VA Arlington - 5/6 2015 - "WABS Arlington-Washington will now switch to post sunset power for listeners in the Arlington-Washington area." (ES-NJ)
- 790 WTAR VA Norfolk - 5/2 2145 - Weather forecast and clear ID and then some news/info items. Fair in among several other stations, new here. (JB-MA)
- 800 CKLW ON Windsor - 5/9 2230 - Good with *Power of Talk* promo and ID as "the new AM 800", collect long distance calls accepted! (BC-NH)

- 820 WQSI MD Frederick - 5/3 2000 - Orioles baseball on "82-Q", fair in WNYC null. (ES-NJ)
- 830 CFJR ON Brockville - 4/20 1930 - Local items, churches, YMCA, etc. "A public service of 830 CFJR." Oldies format over/under WWMO. (ES-NJ)
- 850 WYLF NY Penn Yan - 4/25 1952 - In with ID, MOR music. (LGW-NY)
- 870 WHCU NY Ithaca - 4/21 1940 - Presumed the one with Mets baseball. (ES-NJ)
- 910 WABI ME Bangor - 4/28 2125 - Playing NOS music and gave the weather forecast at 2137 with several IDs. Fair at best in a jumble. (JB-MA)
- 1020 WKZE CT Sharon - 4/22 1929 - Sign off 1929:30 with "Join us tomorrow for more of your favorite music, listen to our sister station WKZE-FM 98.1 for continued fine programming." (ES-NJ)
- 1070 WKOK PA Sunbury - 5/6 1938+ - In unusually well. Songs by *Simon & Garfunkel* and *Elton John*. Ad for *Zimmermann Motors* and CBS news at 2000. (BG-DC)
- 1100 WHLI NY Hempstead - 4/22 2000 - Sign off with SSB by female and "This is WHLI Hempstead - Garden City, New York. Have a pleasant good evening." (ES-NJ)
- 1120 WHTT NY Buffalo - 4/30 2000 - 30 second cuts of 60's oldies to 1959:50, then "AM 1120 WHTT Buffalo" and power off. (ES-NJ)
- 1140 CJTR PQ Trois-Rivieres - 5/1 2030 - Excellent with French AC music on the *Radio Mutuel* network, over WRVA until power reduction at 2050. (BC-NH)
- 1150 CJRC PQ Gatineau - 5/1 2035 - Fair on *Radio Mutuel* network //CJTR, over WMEX null. (BC-NH)
- 1160 WYNS PA Lehighton - 5/11 2125 - Fair with "Pennsylvania State lottery numbers" and "Classic Hits Radio YNS" ID. (BC-NH)
- 1190 WOWO IN Ft. Wayne - 5/7 2159 - Noted simulcasting FM with AM & FM ID during Ft. Wayne Komets hockey game. (BC-NH)
- 1200 WKOX MA Framingham - 4/20 1820 - Station is now playing CW music and ID is "Boston's Country Club WCLB". (JB-MA)
- VA Leesburg - 5/6 2005 - With Orioles baseball, over/under WKOX. (ES-NJ)
- 1270 WTSN NH Dover - 4/28 2000 - ABC news into local news with ID at 2005. (ES-NJ)
- WHLI NY Niagara Falls - 4/29 1945 - Bilingual program SS/EE "Musica Hispana", SS vocals, request line at 773-1270. (ES-NJ)
- 1290 WRCP RI Providence - 5/6 2025 - Up briefly in a real mess before annihilated by WHIO. Could've been PP or SS. (BG-DC)
- 1300 WIMG NJ Ewing - 4/7 2030-2100 - Playing GOS music and songs. At 2059 female announcer gave several WIMG IDs and mentioned the stations inspirational music and general religious orientation. Fair to good. (JB-MA)
- 1310 WDKD SC Kingstree - 4/6 2135-2158 - Playing lots of CW music with several "Carolina Country WDKD" IDs. Coming in really strong at times. New here. (JB-MA)
- 1320 WARA MA Attleboro - 4/25 2028 - ID as "American Sports Net." Nice signal, over and under CKEC. (LGW-NY)
- WARA MA Attleboro - 5/9 2130 - Good with "WARA Attleboro-Pawtucket" ID and the *Sunday Scoreboard* on the *American Sports Network*. (BC-NH)
- WLEE VA Richmond - 5/4 2000 - Dr. Harvey Reuben giving ID. First time heard here, usually too much WJAS. (DB-DE)
- CKEC NS New Glasgow - 4/25 2050 - Heard with end of Billy Graham *Hour of Decision* program. (LGW-NY)
- CJMR ON Mississauga - 4/24 2223-2304 - Playing songs and music of India with mentions of Punjab and a string of commercial ads in Indian language with many mentions of "International Banquet Hall." ID at 2304 as "CJMR, we are the voice of ?." (JB-MA)
- 1350 WSLR OH Akron - 4/21 2240 - CW music, commercial for *Sears/AT&T Days*, PSA on clinical depression. (WW-NJ)
- 1410 WDOV DE Dover - 5/5 2213 - PSAs on Zebra Mussels, drunk driving, a local fair in Dover. "News Radio 1410, WDOV." (WW-NJ)
- 1420 WBSM MA New Bedford - 4/26 1959 - Heard with end of talk show and NBC news. (LGW-NY)
- WCOJ PA Coatsville - 4/22 2205 - With Phillies baseball. (ES-NJ)
- WCOJ PA Coatsville - 4/30 2005 - CNN news into ads and Chester County weather and ID. (ES-NJ)
- 1450 WEWO NC Laurinburg - 4/5 2105-2118 - Oldies music and ID as "AM 1450 Wee-Woh." Commercial ads and the weather forecast at 2116. Fair to good. New here. (JB-MA) (Jim, the log shows this on 1460 - are you sure this was 1450? - db)
- 1470 WLAM ME Lewiston - 5/6 2215 - Heard a WLAM ID and then an announcement of a unique arrangement of using 870 and 1470 to get a wider coverage area. (JB-MA)

- 1590 WAKR OH Akron - 4/30 1945 - With Cleveland Indians baseball. ((ES-NJ)  
 1600 WAYC PA Bedford - 4/27 2005 - Presumed the one with Pirates baseball, list of sponsors, "Pirates Baseball Network". (ES-NJ)

## REPORTERS

- SA-MB Shawn Axelrod, Winnipeg, MB:  
 JB-MA Jim Bagge, Springfield, MA: R5000, HQ145, Longwires  
 BC-NH Bruce Conti, Nashua, NH: R70, DX400, MWDX-5, (2) 60-ft. wires  
 BG-DC Bob Gilfert, Washington, DC: DX-440, MWL-900P, Hyundai H-510  
 LK-ON Laurence Kearley, Orleans, ON: Sony ICF-SW1, Select-a-tenna  
 AM-VA Alan Merriman, Annandale, VA:  
 AM-IL Alan R. Millmaker, Centralia, IL:  
 ES-NJ Elliot Straus, Toms River, NJ: R-390A, Quantum Loop, LW's, MFJ-959B  
 WW-NJ Walter Windish, Wayne, NJ: Icom IC-765, G5RV antenna, Panasonic RF-2600  
 LGW-NY Leslie Wood, N. Merrick, NY: Superadio II  
 DB-DE Dave Braun, Wyoming, DE: R-2000, Palomar Loop

## HALIFAX BAND SCAN

Laurence Kearley spent a night in the "electronically noisy *Holiday Inn*" in Halifax, Nova Scotia on April 27 and sends us the results of three hours of listening. He used a Sony ICF-SW1 and a Palomar Loop, and mentions that the active antenna which came with the SW1 was useless on MW. I have taken the liberty of changing Laurence's times to ELT from Atlantic Time.

- 550 CFNB NB Fredericton - 1941 - Oldies song *My Guy* and call ID.  
 600 CKCLT NS Truro - 1945 - Tentative with the end of Kenny Rogers' *The Gambler* and a local ad.  
 610 CHNC PQ New Carlisle - 1947 - FF talk and news with ID as "Telemedia, Quebec" probable as only other Telemedia on this frequency is not anywhere nearby.  
 630 CFCY PI Charlottetown - 1954 - With a hard rock song "on CFCY", slogan "today's hits and tomorrow's classics" and another rock song.  
 640 CBN NF Saint John's - 2001 - CBC news about next week's election in Newfoundland.  
 700 CHSJ NB Saint John - 2011 - With CW music and DJ *Brent Morris* subbing on "CHSJ country" later call ID.  
 710 UNID 2015 - With a talk show on real estate, probably *Bruce Williams* as mentioned below (850). Show seemed to be called *Inside Information*.  
 720 CHTN PI Charlottetown - 2018 - Rock music, call ID and local weather.  
 730 CKAC PQ Montreal - 2021 - Probable with FF talk show as this is the only FF on frequency.  
 810 WGY NY Schenectady - 2023 - With ID as "Radio 810, WGY" and commercials with strong slop from Halifax local on 780 then a rock song.  
 850 WHDH MA Boston - 2026 - With a phone in show on real estate (Bruce Williams I think) with a later call ID at 2105.  
 880 WCBS NY New York - 2032 - With "WCBS news time is 8:32" and later ID as "Newsradio 88".  
 1010 WINS NY New York - 2037 - Several stations in/out with this one IDing with "WINS news time is 8:37".  
 1030 WBZ MA Boston - 2039 - With talk show host saying "Good evening, you're on WBZ".  
 1050 WEVD NY New York - 2041 - The same real estate talk show mentioned above with "This is Talknet and I'm Bruce Williams" and ID as "WEVD, New York".  
 1070 CBA NB Moncton - 2043 - A CBC broadcast about politics in Alberta.  
 1080 WTIC CT Hartford - 2045 - With a talk show about crime, then Hartford ads and "WTIC, AM 1080".  
 1090 WBAL MD Baltimore - 2046 - Probable based on it being a broadcast of the Orioles and White Sox game.  
 1110 WBT NC Charlotte - 2048 - With "It's 60 degrees at WBT" then back to a phone in show.  
 1130 WBBR NY New York - 2050 - News and ID with "This is WBBR, New York."  
 1180 WHAM NY Rochester - 2054 - With *Bruce Williams* and "The WHAM weather for Rochester and upstate New York is..."  
 1200 WNSW ME Brewer - 2057 - Probable with news from CNN over music.  
 1210 WOGL PA Philadelphia - 2111 - With oldies music and an ID as "Oldies 1210, WOGL".  
 1220 CKCW NB Moncton - 2115 - Rock music and ID as "The Mix" (as do half the stations in North America), and Moncton ads.



- 1280 CKCV PQ Quebec - 2123 - Mix of FF talk and SS talk. This had to be CKCV. Over UNID below.  
 1280 WADO NY New York - 2123 - Mix of SS talk and above FF talk. This is probably WADO. Over UNID below.  
 1280 UNID 2200 - Over/under ones mentioned above with the USA Radio Network news and into a program called *Radio Free America*.  
 1290 WKNE NH Keene - 2125 - With soft rock music, later ID at 2300 and into the Red Sox game at Oakland.  
 1330 WRCA MA Waltham - 2128 - With one of the greatest shows I've heard. Latin socca music with talk in FF, EE and SS on a Caribbean all request show (621-1330) with talk of the islands. Time check at 9:58 and ID as "WRCA Waltham-Boston". Then after 2200 went into a program in FF called *Radio Galaxie*.  
 1350 WINY CT Putnam - 2205 - With Red Sox game.  
 1370 WDEA ME Ellsworth - 2153 - Pre-game show for Red Sox game with local ads, mentions of Ellsworth, phone number 244-7461 and call ID.  
 1375 RFOt St. Pierre et Miquelon - 2140 - Tentative with FF music and talk. I say tentative as I was tuned to 1377 (that's as close as you can get with this Sony!) and the language was not FF from PQ and there was no FF on 1370 nor 1380. Fade and off air at 2200.  
 1470 WSRO MA Marlborough - 2213 - With Red Sox game.  
 1480 WSAR MA Fall River - 2215 - With Red Sox game.  
 1500 WTOP DC Washington - 2217 - With Orioles and White Sox game.  
 1510 WSSH MA Boston - 2219 - Probable with SS music very strong and clear.  
 1540 WPTR NY Albany - 2221 - CNN Headline News with ID as "WPTR, News Radio 1540". Very strong.  
 1560 WQEW NY New York - 2224 - With MOR music and call ID given by Carly Simon. Extremely strong and clear.  
 1580 CBJ PQ Chicoutimi - 2228 - With FF talk and local ad.  
 1600 UNID 2240 - A real mystery with FF talk and severe fade. The FF was definitely not from PQ and was very slow by FF standards. The discussion was about classical music and gave no clues. There are no FF stations listed in the log on 1600, nor in the WRTH from any francophone countries, not even on nearby frequencies. HELP!!

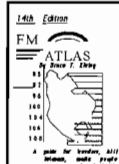

## Bruce Elving's **FM Atlas** ...14th Edition

The world-famous guide which has served FM DX'ers for over 20 years is available from NRC Publications at the special price of \$12.00. NY orders, please add sales tax.



The NRC *AM Radio Log*, 13th Edition, is the most accurate AM radio listing of stations in the U. S. and Canada. Only \$16.95; Canada \$17.95 to U. S./Canadian NRC Subscribers ONLY. \$19.95 to U. S., Non-NRC Subscriber; \$20.95 Canadian Non-NRC Subscriber. Airmail: to Europe, \$27.00, to the Pacific nations, \$32.00.

Mail to: NRC Publications - Box 164  
 - Mannsville, NY 13661 (NY residents add sales tax)



# International DX Digest

Foreign DX Catches. Times are UTC, for ELI, subtract 5 hrs.

Well, things have become much busier around here in the last week, now that our new eight-year-old son Roberto has arrived. It appears that one of the first adjustments in my daily routine is the substitution of DXing for bedtime stories!

Welcome to new reporter Steven Wiseblood, whose listening post is strategically located along the Texas border with Mexico.

## TRANS-PACIFIC DX

774 AUSTRALIA 3LO Melbourne, 4/25 1102 - Good with man doing Australian and world news in Australian accent, new! [SA\*MB]

1017 JAPAN JOLB Fukuoka, 4/25 0950 - Poor with woman in Japanese, faded up for about 3 minutes, my first Japan station! [SA\*MB]

Shawn speaks: "Hets were heard from 531 to about 1100, the best ever, but only two stations good enough to be heard. These two made the walk in the mud and the snow worth it. Temperatures were about 0 to -9 degrees C, but the wood stove kept us warm. Went out to wind up antennas so farmer could work the land. Oh for my 2000 foot west beverage I had to take in, left out a little piece so I could DX a little after a good sleep. Oh well, there is always next year." (ah - Manitoba springtime, the snow melting, farmers starting up their tractors, DXers rolling up their beverages ... Jim)

## TRANS-ATLANTIC DX

999 SPAIN Madrid, 4/9 0335 - Fast Spanish talk by man. [MC-MA]

1098 CANARY ISLANDS and/or SPAIN and UNID (CZECH?), 4/9 0343 - Spanish talk over/under classical music. [MC-MA]

1107 SPAIN 4/9 0347 - Spanish talk, pronounced echo present. [MC-MA]

Jim Renfrew

61 Wilcox Street

Rochester, NY 14607-3832

- 5/6-9 0100-0300 - Strong het against WHIM-1110 heard in WBT null, but never produced any audio, Spain likely. [BC-NH]
- 1125 SPAIN/LIBYA/??? 4/9 0348 - Spanish and Arabic programs blending with other audio in a jumble with low growl typr of hets. [MC-MA]
- 1179 SPAIN 4/9 0353 - Spanish talk to good peaks. [MC-MA]
- 1251 LIBYA Tripoli, 3/31 0243 - Excellent with man in Arabic. [MC-MA]
- 1305t SPAIN 4/9 0357 - Spanish-sounding talk, in slop. [MC-MA]
- 1359 SPAIN (and MELILLA?) 3/21 0600 - Excellent with man and woman in Spanish. This is one of the most consistent TAs in the Boston area 4/9 0359 - Like a local! [MC-MA] (see Station News for update about Melilla - Jim)
- 1368 UNID 3/31 0304 - Possible Spanish or Portuguese talk, hetted by Angola 1367. [MC-MA]
- 1386 UNID 3/31 0303 - Fat carrier, bits of talk and music. [MC-MA]
- 1413 SPAIN 4/9 0400 - News in Spanish by man. [MC-MA]
- 1530 VATICAN 3/31 0250 - Loud with Slavic-sounding talk by woman // 6245. Burying WCKY totally! Third audio present at times, not sure if this was the Arabic station recently noted by Burnell. [MC-MA]
- 1548 ENGLAND 3/31 0257 - English talk, poor. [MC-MA]
- 1575 SPAIN/GERMANY 4/9 0405 - Spanish and German programs mixing. [MC-MA]
- 1584 SPAIN 3/21 0604 - Woman in Spanish, fair to good. 4/9 Spanish talk, choppy. [MC-MA]
- 1593 GERMANY Langenberg 3/31 0258 - Rock music, fluttery fades. 4/9 0407



- to strong peaks with "Down Under" by Men at Work (1982 hit). 4/11 0424 - Excellent with soul hit "Wishin' on a Star". [MC-MA]
- 1611 VATICAN 3/31 0253 - Good with fast Slavic talk, killing Anguilla 1610. [MC-MA]

## PAN-AMERICAN DX

- 700 JAMAICA JBC-1 Montego Bay, 5/4 0256-0302 - Sports talk program with talk of NBA playoff games. Announcer greeting callers "Hello ... Good Night" (where "Good Evening" would be appropriate in the USA), 0259 ID "JBC Radio One", mention of Montego Bay, into love songs programs of romantic music, 0300. [SCW-TX]
- 740 MEXICO XEGF Gutierrez Zamora VER, 4/19 2343 - Heard in null of KTRH-740, musica popular, jingle "740 AM Stereo", and as "740 R. Fiesta", ads, mentions of Gutierrez Zamora and Poza Rica, full ID "XEGF 740 con 2 mil watts de potencia en Gutierrez Zamora", also gave address and telephone number. This frequency reflects a change from 1420 kHz as listed in 1993 WRTH. (Daytime reception over water path). [SCW-TX]
- 740 CUBA R. Progreso, 5/2 0548 - The only LA station noted tonight, and very weak, single ID heard. [JR-NY]
- 750 VENEZUELA R. Caracas, Caracas, 5/12 0200 - Good with Radio Caracas ID and "red nacional de noticias - llamada Caracas" news/talk program, over WSB. [BC-NH]
- 760 NICARAGUA R. Sandino, 5/4 0125 - IDs "La S Grande". "Noticias Eco" with news headlines by man announcer, 0158 LA pop music. [SCW-TX]
- 850 MEXICO XETQ Orizaba Veracruz, 4/26 0356 - ID "XETQ, La Nueva en su música", mention of 10 mil watts de potencia, lite Mexican pop music. [SCW-TX]
- 860 HAITI 4VKM Les Cayes, 4/18 1525-1600 - Music, orchestra and choirs, French talk, poor, no interference; almost like REL at times. [DT-JAM]
- 890 CUBA R. Progreso (cf 900, WRTH lists 50 kW, QTH as Cacocum), 4/18 0020 - TC as "8:30" indicating EDT time, talk by man with mention of the origins of cuban rhythms derived from African music, 0030 ID "Radio Progreso", mention of Havana, mix of salsa/pop music, very strong. [SCW-TX]

- 890 MEXICO XE?? Tuxpan VER, 4/19 2335 - In null of KVOZ Laredo, lite pop music, slogan by man "ocho noventa" repeated numerous times, mention of Ciudad de Tuxpan. 4/20 2357 - Heard again with KVOZ off the air, "musica romántica", numerous "890" slogans, man announcer greeting listeners, ads, 0005 birthday greetings, "musica tropical y romántica", mention of Tuxpan 0031, program of listeners' requests and dedications (daytime over water path). [SCW-TX]
- 895 ST. KITTS & NEVIS VON, Nevis, 5/12 0100 - Good with "Power from the Tower, VON Radio" ID and soca/soul/reggae music. [BC-NH]
- 930 MONTSEERRAT R. Antilles, Plymouth, 4/19 2100-2106 - VOA relay news, fair over R. Relej. [DT-JAM]
- 930 MEXICO XEU Veracruz VER, 5/9 2034 - Ads, promo for concerts, ID "es la U de Veracruz" jingle, into live fútbol broadcast with two men announcing. (Over water path daytime reception). [SCW-TX]
- 950 MEXICO XETO Tampico TAM (cf 1400), 4/20 0023 - ID "XETO Radio Recuerdas 1 mil watts de potencia en Tampico", música romantica, also had one single taped ID "Recuerdo" by woman between songs (daytime over water path). [SCW-TX]
- 1010 MEXICO XEHL, Guadalajara JAL, 5/11 0308 - Full ID "XEHL Guadalajara Jalisco" by man announcer, into Mexican popular - cumbia music, jingles 0310 as "HL", promo for música banda concierto, "La Poderosa", slogan 0311. [SCW-TX]
- 1020 MEXICO XEPR Poza Rica VER (cf 1480), 4/19 0314 - Full ID as "XEPR Poza Rica", ads, música romantica, "La Hora Azul" featuring music "de los trios, WRTH lists as 5 kW. [SCW-TX]



- 1030 MEXICO XEMPM Los Mochis SIN, 5/4 0150 - TC for "10 minutes before seven" indicating Mountain Standard Time, slogan "R. Fama", lite popular mexican music, jingle "R. Fama", ID 0200 with mention of 1 mil watts de potencia". [SCW-TX]
- 1030 MEXICO XEQR Mexico City DF, 5/11 0201 - Full ID, programa de música romantica, mention of "el Ciudad de Mexico", ads, música de trios. [SCW-TX]
- 1100 ANTIGUA ZDK St. John's, 5/12 0120 - Fair with "magic" IDs and urban contemporary music, in WWWE null. [BC-NH]
- 1101a UNID (probably CUBA) 4/9 0345 - Man and woman here in Spanish; signal created a raucous, ripping het against the usual WWWE/ZDK/ others on 1100. [MC-MA]
- 1150 CUBA?? R. Cubano 3/21 2230-0000 - Jazz, Billie Holliday, Sarah Vaughn, Ella Fitzgerald, ID at 0000 as R. Cubano, good. [DT-JAM] (Possibly R. Bayamo? - Jim)
- 1195t HAITI 4VAF, Jeremie, 3/21 2058-2150 - Man and woman talking in French, no ID heard, fair. [DT-JAM]
- 1270 MEXICO?? XEYW, Mérida, 3/25 2048-2118 - Ranchera-type music, no definite ID heard, Mexico mentioned, could be someone else, poor. [DT-JAM]
- 1340 GUANTANAMO WGBY Guantánamo Bay, 3/15 1437 - Item on disposable cameras, UPI Round Table program, good, no interference. [DT-JAM] (This one is considered a separate country on most lists - Jim)
- 1375 ST. PIERRE & MIQUELON 5/8 0305 - Surprisingly strong signal with French talk, despite heavy slop from WFEA-1370 and WSYB-1380. [BC-NH]
- 1410 MEXICO unID 3/29 2110-2200 - Electronic music, string orchestra, clarinet solo, JAZ or BBD, piano solos, 2100 woman announcer in Spanish, no ID, suspect XEBS, but could be someone else. [DT-JAM]
- 1500 MEXICO XEGN Piedras Negras VER, 4/23 1203 - ID "XEGN La Super G en Piedras Negras, Veracruz", musica banda, rancheras, ads. [SCW-TX]
- 1580 CUBA CMHP Santa Cruz, (no date), 1455-1500 - LA music, ID as R. Cadena Agramonta, good. [DT-JAM]

## STATION NEWS

CAMBODIA: Radio UNTAC (United

Nations Transitional Authority in Cambodia) programs are heard on VOA Thailand 1575, since November on 918 kHz Phnom Penh (120 kW), and new 25 kW transmitters at Siem Reap 539 kHz, Stung Tren 650 kHz and Kompong Tom 720 kHz. R. UNTAC plans to be on the air 0530-0700, 1100-1230, and 1800-1930 local time, daily. [Martin Hadlow UNESCO in DX Australia 4/93]

CUBA: From Russell Scotka: Regarding Ernie Wesolowski's 1001 kHz unID QRM - its CMAC R. Guama. "They aren't operating at the 10 kW noted in the WRTH and frankly I think the transmitter is getting ready to go belly up because they are making one mess of that frequency here. Of course, it could be intentional jamming to keep the Colombian from getting through. They occasionally end the broadcast day on 1020 but never drop the transmitter off line, instead they substitute some kind of fuzz for modulation and crater that frequency all night. Lots of the locals are slightly off frequency and I can only speculate as to whether it's to interfere or they can't get the parts for the equipment or daily brown-outs are taking their toll on the finals?" Russ also notes that Terry Krueger reports Taino has been lurking on 890.

DUBAI: DXer Hans Johnson heard the following during a March visit: 657 Abu Dhabi, Urdu rather than Arabic // 810 at 1319; 1122 Iran, Home Service probably Bandar Lengeh on 1116 off frequency // 90.1 MHz; 1224 Iran? (clandestine) Voice of the Islamic revolution in Iraq 1415 in both standard and Iraqi Arabic, unjammed, strong with ID at 1430; 1413 Oman BBC easily heard in Dubai; 1476 Dubai Arabic Service is back on frequency rather than listed 1481. [Hans Johnson in NSAWA Journal 5/93]

INTERNATIONAL WATERS: A radio ship fitted out in Galveston, Texas is said to be on its way to the North Sea with three 50 kW transmitters on board (one SW and 2 MW) to broadcast religious programs. [Medium Wave News 5&6/93]

INTERNATIONAL WATERS: A radio station carrying independent news to the remnants of Yugoslavia, and financed by the European Community (\$1.2 million for the first month, thereafter through private donations), began broadcasting from a ship near Bari, Italy, on April 7. R. Brod (Radio Boat) operates on 720 kHz with 50 kW and on 90 MHz FM. It can be heard in northern Europe around 0300 when some co-channel stations are silent. The staff of seven include a



Slovene, two Croats, two Monenegrins, a Serb, and a Bosnian Muslim. Its director, Agitsa Panorats, says they hope to make a dent in the propaganda war that has accompanied the ground fighting ... The station is located on a former oceanographic vessel named "Droit de Parole", which means "The right of speech". The 65 meter-long ship flies the flag of St. Vincent and the Grenadines, in the Caribbean, and depends on the port of Bari for supplies ... In response to questions about legality, the director states that "there are higher moral objectives at stake here: We are not like Radio Caroline, fighting to have a few hours of pop music and working on commercial programs. We are fighting, first for the dignity of professional journalists. We are fighting to stop the war and re-establish dialog. We are fighting to try to make communication among those parts of Yugoslavia which do not communicate anymore, especially members of the families all over ex-Yugoslavia which at the moment are not able to give a message or talk to each other. This is what gives legitimacy to the project." [excerpts from transcript of Radio Nederland Media Network interview 4/15 in NASWA Journal 5/93]

KALININGRAD R. Moscow World Service replaces R. Ala on 1386. [OA in ARC 4/17/93] ( I read somewhere that R. Ala couldn't pay the bills for transmitter time on R. Moscow facilities - Jim) MELILLA: "According [to] the new R. Nacional España medium wave list edited in March, R. 1 RNE Melilla is reported only on 972 (ex-1359 kHz)!" [Play-DX #739, 4/26/93]

NETHERLANDS: Dutch "lausteramateurs" who specialize in traditional Netherlands country music on weekends hang out around 1610-1640 kHz between 0000-0300 Saturday and Sunday. A few of them had ventured down into the regular MW band but found the QRM too much. The Dutch pirates began around 1610 kHz, but are now mostly between 1622-1640 kHz. A few of them have made it across the pond to Newfoundland and Canada. They operate amateur fashion, which means that they talk to and play music for each other. Stations which announce their addresses are rare, although the Dutch PTT does not raid them because it has more important work to do. [John Campbell and JM on RNMN 4/1 in NASWA Journal 5/93]

PANAMA: HOPU "Lider 540" (ex-Emisora Lider, 550 kHz) [LARP in ARC 4/17/93]

RUSSIA: VOA Relay 648 Ussuriysk 1000 kW 1300-1400 Korean. [VOA BBS in NASWA 5/93]

THAILAND: Jamming has come to the Far East and is pretty severe on a lot of channels. The 1000 kW VOA transmitter on 1575 was clear in mid-February, but in late March

jamming began at 1330-1700, including Khmer as well as Mandarin and Cantonese. [AC on Radio Nederland Media Network in NASWA Journal 5/93] (NASWA editor Mike Ferguson adds that the jamming sounds like ball bearings falling on a carpeted floor - Jim)

UNITED KINGDOM: Virgin 1215 went live 8am-8pm in mid-April then extended hours 5am-midnight. Also now on Astra satellite. [Steve Whitt in Medium Wave News 5&6/93]

## QSL INFORMATION

ENGLAND: GCC1, 1615 kHz, BRITISH TELECOM, CULLERCOATS RADIO, BT Station, WHITLEY BAY, Tyne and Wear, NE26 2PD, ENGLAND; QSL card. [HH-MD]

## CONTRIBUTORS

- [JR-NY] Jim Renfrew, Rochester NY; Sony ICF-2010, Radio West Loop.
- [DT-JAM] Don Trelford, St. Ann's Bay, Jamaica.
- [SA\*MB] Shawn Axelrod, Valhalla Beach MB; ICOM ICR-70, beverages west and south about 500 feet.
- [MC-MA] Mark Connelly, Billerica MA; Drake R8, JRC NRD 525; 20m wire and 37m wire with noise-reducing transformers to MWDX-5 Phasing Unit and MWT-3 Regenerative Preselector.
- [BC-NH] Bruce Conti, Nashua NH, R70, DX400, MWDX-5, 2 60 foot wires.
- [HH-MD] Hank Holbrook, Dunkirk MD; SONY AIR-8 with whip, Realistic DX-400 with 50 foot longwire.
- [SCW-TX] Steven C. Wiseblood, Brownsville TX; GE Superadio II.

## DX OK IN THE UK

- Here are some of the stations that Tom S. heard on a recent stay in the United Kingdom:
- 234 LUXEMBOURG RTL, 3/24 2200-2400, 3/25 0700-0900 - Strong, steady signal all day in London; in French with French CHR and 60's-70's American rock and blues.
- 828 UNITED KINGDOM Luton, 3/19 2300-2400 - IDs as "Luton Radio 828, Sungold" on the Chiltern Radio Network with olies and local Luton inserts. Request line is Bedford 0345-078-078; also heard reminders for listeners to pick up new car stickers at their local "Supergold" stations. Fair signal with occasional TVI, with 200 watts 30 miles from Luton in West London.
- 1215 UNITED KINGDOM Virgin 1215 - Testing on air during week of 3/19-3/25. On all day with the same hour of music repeated continuously;

about half current rock and half classic rock from the past 25 years. Also frequent announcements explaining the tests and noting that regular programming would start 4/30. Address for more info: Virgin 1215, 1 Golden Square, London W1R 4DJ. Heard on 1215 in London, Hereford, and Liverpool.

1548 UNITED KINGDOM City Gold, Liverpool, 3/21/22 2200-0200 - With a talk show and 3 or 4 records

per hour. Weak unID way underneath with oldies, possibly Capital Gold? City Gold is full service; with oldies, IRN news, a job line feature and "tradio" from 1400-1500. Heard while in Liverpool. (Tom, my apologies for pitching your envelope with your last name on it. Please write in and identify yourself so I can report your last name - red-faced Jim)

## FM DX

### Digest

DX on the FM band, from April through September

**Mike Hawk, NØOSY**

10212 P St.

Omaha, NE 68127-2130

E skip has been very slow so far, compared to last May. However, it should be picking up by the end of May.

There has been a little tropo in the south and east, the best of which was some Gulf tropo reported in Florida. I forgot to mention in the last FMDXD that tropo is usually more common over warm waters, so those of you living around the Gulf of Mexico should be ready for some great DX!

Please note Russ Edmond's unIDs. Also, Rick Dau of IA called with an unID on 104.7, which sounded like WLMD. Can anyone help?

This is my first submission to DXN on disk, so please bear with me as I get the bugs worked out.

**William Wyllie - 95 Peck ST - Franklin, MA 02038-2217**

Equipment: Realistic Modulaire 2200 with built in antenna.

3/28 (no times listed)

95.1 WRKI CT Brookfield - Strong with "I-95" rock music

95.7 WKSS CT Hartford - Rock music, sounded like DISCO. Long song with ID's here and there. "You're listening to Kiss 95.7 House Mix". Station not heard much.

97.3 WZBG CT Litchfield - Strong, first time logged. Lite rock music. ID as "You're listening to 97.3 WZBG Litchfield"

97.9 WPXX MA Enfield - Strong with country music. "Kicks 97.9." Heard once before.

98.7 WXOD NH Winchester - Noted "Oldies 98.7". Mention "Pat Thomas" show weekdays. Good signal. Note sure

**WERK**  
Oldies 105 FM

8510 South State Road 3  
Muncie, IN 47302

**Russ Edmonds - 753 Valley Road - Blue Bell, PA 19422-2052**

Equipment: Delco car radio with whip

The following are changes (from those listed in the 14th Edition of the FM Atlas).

92.3 WMGS GA Macon - ex-WVPI is country. Slogan is "Kissin' Country or 'Kissin' 92.3". Only ID hrd 1200 4/30 as I was heading back to Atlanta, and was garbled so not certain on the call. Not yet on air 8/91.

92.7 WKKZ GA Dublin - is now soul/dance  
95.9 WQZY GA Dublin - off air 4/26-30 at least

97.5 WUFF GA Eastman - is here, ex 92.1. Is still WOOF-FM

97.5 WEZK TN Knoxville - is now EZ 97.5  
97.9 WKXX GA Fort Valley - is now "Foxy 98"

98.7 WPUR GA Americus - is here, ex-97.7.  
99.1 WAYS GA Macon - is now oldies

100.9 WPGA GA Perry - is now rock  
101.1 WROQ SC Anderson - ex-WCKN, still classic rock.

101.7 WRCC GA Warner Robbins - ex-WPPR. Is country.

103.7 WPUP GA Royston - is soul/danc, and is "Bulldog 103.7"

104.3 WBBQ GA Augusta - is now rock  
105.9 WRHY AL - w/rock/MOR. "Y-106, the perfect mix" and "Serving NE Alabama".

Owing to geography, power, antenna, I would suspect that this is the Trussville, rather than the Centre CP listed in the 14th edition

106.1 WZLI GA Toccoa - now MOR/rock (mix format)

107.1 WNEF GA Gordon - ex-WYGO and is beautiful music

107.3 WCGQ GA Columbus - now rock  
107.5 WDBN GA Wrightsville - ex 106.3, but I

won't swear to the call, as I never heard an ID, just persistent "Mix 107.5" slogans. Is MOR/rock.

Now Russ' DX from Macon:

4/27

2246 WMJJ AL Birmingham - "Magic" w/rock o/u normal WDOE-TN

2210+ unID - with syndicat Ron and Ron Show" over the "Ron and Ron Radio Network" w/rock and chatter

00 16 97.5 WABB AL Mobile - ID and pop music.

0020 96.5 KHMV TX Houston - local public service announcement and "Mix 96.5" non-ID.

0101 96.1 WAVH AL Mobile - Legal ID over the hour.

0114 98.5 WFSY FL Panama City - "Sunny 98.5" non-ID.

Though the distance of the TX catches (849 miles) would suggest E skip, this was probably tropo considering 1) the signals did not exhibit the fading associated with skip, 2) I was also getting several gulf area stations on TV, including tentative reception of TX on channel 11, where skip rarely reaches, and 3) a local ham friend mentioned that he was hearing LA hams on 2 meters (144 MHz). [Also, the time helps prove that it was tropo. Look for more Gulf tropo, Mike, as it should be fairly "common" for your location, occurring a few times every year. -mrh]

**Russell L. Scotka - 6936 NW 6th Ct. - Margate, FL 33063**

Equipment - Pioneer SX-838 w/McVey [of WTFDA fame - mrh] designed 5 filter cascaded IF mod and Archer VU-190 on 20' mast w/rotor.

4/14 (all heard between 1820-2230 EDT)

88.1 WRJA SC Sumter - Fair w/NPR Morning Edition

88.3 WLPT GA Jesup - Strong w/rel program. ID at 2005

93.5 Dobleve CUBA - Santa Clara - Strong over two locals w/SS nx, numerous mentions of Villa Santa Clara and "w" ID's dominant early (1830) faded later. No other CM stations noted.

95.1 WAPE FL Jacksonville - Usually heard here weak thru WZTA. Was blasting thru tonight with strong stereo.

96.3 WRXR GA Aiken - Good signal, rock music. "Rock 96" slogan

97.7 WHTK SC Port Royal - C&W format, ads for Hilton Head businesses, "New Country K" slogan

98.1 WGNF FL Daytona Beach - C&W format. This the lesser heard Daytona stn here. 94.5 WCFB is heard almost daily and is also C&W.

104.5 WFYV FL Jacksonville - Same as 95.1 w/crushing stereo, "Rock 105" slogan

I was surprised to find the Bahamas absent on 104.5 during this event. They come in consistently in the mid-afternoons but don't seem to stay on late unless it's a special occasion. Last heard them on really late Christmas Eve '92.

of call letters-sounded like WXOB. First time heard. [Note calls, William - mrh]

98.9 WCLZ ME Brunswick - With call that I swear DJ said WCLT (unless I heard it wrong), but I heard Brunswick and Portland, also.

3/30

102.1 WZEA NH Hampton - Fuzzy but good over Rock 103 WGIR-FM. ID as "Seacoast 102", then rock music. ID as "WZEA Hampton, Newington, Newberryport (MA). CNN News

102.9 WPXC MA Hyannis - Fair to poor with Pixy 103. Rock.

102.9 WBLM ME Portland - Came up briefly with WBLM and rock music.

William also needs help finding the addresses for WZBG, WXOD, and WZEA, all of which were logged above. He also notes that WKPE, 10.7 in Orleans, MA is now Oldies 104 (prev. rock).

**Mike Jeziorski - 6915 Middleton Ave - St. Augustine, FL 32086-8168**

Equipment: Sony ICF 2010 with whip, Technics SA-222 stereo receiver with 3' dipole.

4/13 Tropo

0004 104.1 KRBE TX Houston - under WWNZ with legal ID.

0009 93.7 KLTR TX Houston - non-ID as "The new K-lite"



and phone-in at 1-800-741-8383. Also heard a slogan sounding like Q-102, o/u WGMG Crawford, GA.

4/28 1823 unID - "Rock 103" w/promo for WOCC TV 38.

Now, Philadelphia news from Russ:

100.3 WPLY PA Media - "Y-100" changed from WKSZ "Kiss-100". Was soft rock, now slightly less so.

101.1 WEAZ PA Philadelphia - is now "B-101.1" ex "EZ 101". Was soft rock, is now slightly less so. I expect a call change.

103.9 WDRE PA Jenkintown - is now rock, formerly ethnic/religious WITF

106.1 WJJZ PA Philadelphia - changed from rock to soft jazz WEGX 4/5/93

Me- Omaha, NE Equipment: Kenwood KT-815 and 10 element Antennecraft at 30'

4/18 Tropo

0850 97.5 KMOD OK Tulsa - fair with special on the Beatles. ID "97.5 KMOD, The past, present, and future of rock and roll"

5/13 E skip

1934 92.1 WFEZ FL Williston - weak with an ID just before fadeout

1936 88.1 WHIJ FL Ocala - Religion. First new catch of the season.

WMBM		Miami Beach	Mike Csorbay	Canfield, ON	1191
WCKC		Milton	Steve Francis	Alcoa	399
WTTB		Vero Beach	Steve Francis	Alcoa	600
WSIR		Winter Haven	Shawn Axelrod	Orlando, FL	34
WMOG	GA	Brunswick	Don Lynch	Wilbraham, MA	907
WMJM		Cordele	Don Davis	Warner Robins, GA	50
WAJF		Decatur	Bruce Winkleman	Man, WV	355
WMLS		Monroe	Jason Hustedt	Lexington, SC	144
WSFB		Quitman	Don Lynch	Lynn, MA	1063
WSNT		Sandersville	Ernie Cooper	Provincetown	990
WSYL		Sylvania	Mike Csorbay	Canfield	715
WRDL		West Point	Don Trelford	Runaway Bay, JMC	1111
KCID	ID	Caldwell	Esa Hänninen	Lemmenjoki	4435
KKLB		Chubbuck	Esa Hänninen	Lemmenjoki	4431
WKRO	IL	Cairo	Russ Edmunds	Glen Rock, NJ	851
WDAN		Danville	Niel Wolfish	Winnipeg, MB	848
			Shawn Axelrod	Winnipeg	(Tie)848
			John Malicky	Pittsburgh, PA	546
WESL		East St. Louis	Wayne Heinen	Buffalo, NY	460
WOPA		Oak Park	Niel Wolfish	Willowdale, ON	541
WZOE		Princeton	Niel Wolfish	Winnipeg	961
WKBV	IN	Richmond	Steve Francis	Alcoa	427
WNDU		South Bend	Esa Hänninen	Lemmenjoki	4220
KBUR	IA	Burlington	Wayne Heinen	Colorado Springs, CO	778
WDBQ		Dubuque	John Wilkins	Wheat Ridge	617
KXLQ		Indianola	Esa Hänninen	Lemmenjoki	4110
KRIB		Mason City	Olle Alm	Abisko, Sweden	4318
KKAN	KS	Phillipsburg	Esa Hänninen	Lemmenjoki	4417
KTOP		Topeka	Tim Kerfoot	Weston, ON	472
WFKY	KY	Frankfort	Frank Merrill	Milan	352
WKAY		Glasgow	Robert Kramer	Chicago, IL	418
WFXV		Middlesboro	Niel Wolfish	Toronto	573
WOMI		Owensboro	Paintsville	Waterloo, ON	407
WSIP		Paintsville	Charles Reh	Leamington, ON	867
WKKC	LA	Bogalusa	Steve Francis	Alcoa	584
KJIN		Houma	Charles Reh	Leamington	859
KRUS		Ruston	Dave Yocis	Fairfield, CT	250
WTVL	ME	Lewiston	Esa Hänninen	Lemmenjoki	3600
WPOR		Portland	Charles Reh	Leamington	673
WTVL		Waterville	Andy Rugg	Montreal, PQ	455
WARK	MD	Hagerstown	Jerry Starr	Youngstown, OH	516
WHAV	MA	Haverhill	Christian DeHaes	Chicoutimi, PQ	436
WMRC		Milford	Jerry Starr	Youngstown	420
WTVL		West Springfield	Esa Hänninen	Lemmenjoki	4009
WABJ	MI	Adrian	Rodney Valdron	Petit Rocher	975
WAND		Manistique	Niel Wolfish	Winnipeg	791
WMPX		Midland	Shawn Axelrod	Winnipeg	(Tie) 791
			Don Voorhies	Oswego, NY	489
WPBK		Whitehall	Russ Edmunds	Parsippany	1111
KXRA	MN	Alexandria	Shawn Axelrod	Winnipeg	309
KQDS		Duluth	Roy Millar	Marysville, WA	1322
KLGR		Redwood Falls	Frank Merrill	Milan	855
WLOX	MS	Biloxi	Charles Reh	Leamington	724
WCLD		Cleveland	Jerry Starr	Youngstown	731
WHOC		Philadelphia	Ralph Sperry	Fairfield, CT	1180
WTUP		Tupelo	Sreve Francis	Alcoa	462
WJFL		Vicksburg	Frank Merrill	Milan	661
KDMO	MO	Carthage	Shawn Axelrod	Winnipeg	874
KTTR		Rolla	Shawn Axelrod	Winnipeg	813
KDRD		Sedalia	Esa Hänninen	Lemmenjoki	4279
KDBM	MT	Dillon	Shawn Axelrod	Winnipeg	621
KXGF		Great Falls	Esa Hänninen	Lemmenjoki	4199
KLYN		Laurel	Esa Hänninen	Lemmenjoki	4282
KEZO	NE	Omaha	Jerry Starr	Youngstown	511
WEMJ	NH	Laconia	Andy Rugg	Nuns' Island, PQ	125
WLGW		Lancaster			

# Graveyard Achievements

Bill Hale

495 Creekview Drive  
Meridian, ID 83642-3241

Distance records for stations logged on graveyard frequencies

1490 kHz

Logged from Jan 1, 1960 to Present

AM  
"Radio Kico"  
1490

Date of Last Update: Apr 10, 1993

KICO-AM

WAJF	AL	Decatur	Neil Wolfish	Toronto, ON	745
WHBB		Selma	Frank Merrill	Milan, MI	687
AFRN	AK	Campion	Esa Hänninen	Lemmenjoki, Finland	3209
AFRN		Eielson AFB	Frank Merrill	Nenana, AK	52
KBAS	AZ	Bullhead City	John Wilkins	Wheat Ridge, CO	599
KCUZ		Clifton	Rick Carr	Bloomington, IL	1168
KYCA		Prescott	Jeff Tynan	Parker, CO	543
KAJR		Tucson	Laurie Boyer	Invercargill, NZ	7386
KZAO	AR	Dardanelle	Stephen Ponder	Harrison, AR	74
KDRS		Paragould	Shawn Axelrod	Winnipeg, MB	1033
KOTN		Pine Bluff	Carl Dabelstein	Lincoln, NE	510
KARV		Russellville	Steve Francis	Alcoa, TN	519
KWAC	CA	Bakersfield	Olle Alm	Abisko, Sweden	4947
KGUD		Banning	Tim Hall	Chula Vista, CA	90
KOWL		Bijou	Pete Taylor	San Francisco, CA	160
KICO		Calexico	Mike Sanburn	Bellflower, CA	185
KRKC		King City	Frank Merrill	Nenana	2266
KTOB		Petaluma	Frank Merrill	Nenana	2107
KBLF		Red Bluff	Jim Hilliker	Anaheim, CA	498
KDB		Santa Barbara	Richard E. Wood	Hilo, HI	2393
KOWL		South Lake Tahoe	Esa Hänninen	Lemmenjoki	4791
KSVC		Yreka	Esa Hänninen	Lemmenjoki	4634
KBOL	CO	Boulder	Esa Hänninen	Lemmenjoki	4519
KGUC		Gunnison	Jeff Tynan	Parker	133
KIIQ		Manitou Springs	John Wilkins	West Des Moines	612
WGCH	CT	Greenwich	Rodney Valdron	Petit Rocher, NB	610
WNLC		New London	Russ Edmunds	Little Silver, NJ	122
WTOR		Torrington	Russ Edmunds	Little Silver	114
WTRL	FL	Bradenton	Frank Merrill	Milan	1013
WXVQ		Deland	Karl Jeter	Stone Mountain, GA	375
WKEM		Immokalee	Ernie Cooper	Provincetown, MA	1253



WIKE		Newport	Charles Reh	Leamington	580
WUSS	NJ	Atlantic City	Debra Hidden	Orlando, FL	860
KRSN	NM	Los Alamos	John Wilkins	Wheat Ridge	277
KRTN		Raton	Tim Hall	Rancho Bernardo, CA	767
KOAW		Ruidoso Downs	Tim Hall	Rancho Bernardo	668
WCSS	NY	Amsterdam	Morris Sorensen	Port Carling, ON	303
WBTA		Batavia	Russ Edmunds	Little Silver	286
WKNY		Kingston	Frank Merrill	Milan	496
WICY		Malone	Charles Reh	Leamington	446
WDLC		Port Jervis	Don Trelford	Scarborough, ON	286
WCDO		Sidney	Mike Csorbay	Canfield	188
WOLF		Schenectady	Laurie Boyer	Invercargill	9348
WAQX		Syracuse	Morris Sorensen	Port Carling, ON	218
WSSB	NC	Durham	Andy Rugg	Montreal	705
WLOE		Eden	Russ Edmunds	Kinnelon, NJ	430
WFLB		Fayetteville	Tim Kerfoot	Weston	599
WRNB		New Bern	Dave Fox	Reading, PA	370
WRMT		Rocky Mount	Andy Rugg	Montreal	705
WSTP		Salisbury	Charles Reh	Leamington	452
WSVM		Valdese	Frank Merrill	Milan	449
WHSL		Wilmington	Tim Kerfoot	Toronto, ON	655
KNDC	ND	Hettinger	Olle Alm	Abisko, Sweden	3982
KOVC		Valley City	Roy Millar	Marysville	1137
WBEX	OH	Chillicothe	Bill Alisauskas	Douglasville, GA	378
WJMO		Cleveland Heights	Chris Lucas	Fairfield	430
WOHI		East Liverpool	Robert Kramer	Chicago	377
WMOA		Marietta	Steve Francis	Alcoa	284
WMRN		Marion	Niel Wolfish	Winnipeg	978
			Shawn Axelrod	Winnipeg	(Tie) 978
KOKC	OK	Guthrie	Esa Hänninen	Winnipeg	4620
KBIX		Muskogee	Niel Wolfish	Winnipeg	1000
KBKR	OR	Baker	Esa Hänninen	Winnipeg	4374
KRNR		Roseburg	Esa Hänninen	Winnipeg	4541
KBZY		Salem	Esa Hänninen	Winnipeg	4420
WESB	PA	Bradford	Esa Hänninen	Winnipeg	3894
WAZL		Hazleton	Andy Rugg	Montreal	330
WARD		Johnstown	Don Lynch	Lynn	435
WGAL		Lancaster	Charles Reh	Leamington	354
WBCB		Levittown	Morris Sorensen	Kirkland Lake, ON	671
WMRF		Lewistown	Niel Wolfish	Toronto	228
WMGW		Meadville	Esa Hänninen	Winnipeg	3945
WAGO		Reading	Don Trelford	Scarborough, ON	290
WNBT		Wellsboro	Charles Reh	Leamington	271
WSIB	SC	Beaufort	Steve Francis	Alcoa	416
WGCD		Chester	Steve Francis	Alcoa	174
WMRB		Greenville	Robert Kramer	Chicago	570
WSDC		Hartsville	Russ Edmunds	Little Silver	515
KORN	SD	Mitchell	Charles Reh	Leamington	788
WOPI	TN	Bristol	Andy Rugg	Montreal	750
WDXB		Chattanooga	Carl Dabelstein	Lincoln, NE	730
WCSV		Crossville	Charles Reh	Leamington	440
WITA		Knoxville	Charles Reh	Leamington	427
WJIM		Lewisburg	Mike Csorbay	Canfield	641
WDXL		Lexington	Tom Sundstrom	Willingboro, NJ	825
KNOW	TX	Austin	Roy Millar	Marysville	1779
KBST		Big Spring	John Wilkins	Wheat Ridge	548
KQTY		Borger	Shawn Axelrod	Winnipeg	988
KZZN		Littlefield	Shawn Axelrod	Winnipeg	1125
KDOK		Tyler	Steve Francis	Alcoa	690
KJQN	UT	Ogden	Olle Alm	Abisko	4449
WKVT	VT	Brattleboro	Rodney Valdrón	Petit Rocher	480
WFAD		Middlebury	Mike Csorbay	Canfield	339
WIKE		Newport	Don Trelford	Scarborough	436
WYKR		Wells River	Rodney Valdrón	Petit Rocher	395
WCVA	VA	Culpepper	Andy Rugg	Montreal	525

KNDC  
HETTINGER, N. D.  
58639

WPAK		Farmville	Mike Csorbay	Canfield	397
WVEC		Hampton	UK DXPedition £	Sheigra, Scotland	3445
WAYB		Waynesboro	Don Lynch	Lynn	514
KBRO	WA	Bremerton	Esa Hänninen	Winnipeg	4239
KVAC		Forks	Esa Hänninen	Winnipeg	4229
KEYG		Grand Coulee	Esa Hänninen	Winnipeg	4180
KGHO		Hoquaim	Tim Hall	Vancouver, BC	161
KLOG		Kelso	Esa Hänninen	Winnipeg	4324
KENE		Toppenish	Esa Hänninen	Winnipeg	4294
KTEL		Walla Walla	Esa Hänninen	Winnipeg	4295
WXIT	WV	Charleston	Rodney Valdrón	Petit Rocher	1030
WTCS		Fairmont	Frank Merrill	Milan	257
WLOH		Princeton	Frank Merrill	Milan	347
WSGB		Sutton	Stephen McIntire	Des Moines, IA	675
WGEZ	WI	Beloit	Shawn Axelrod	Winnipeg	680
WLCX		LaCrosse	Jerry Starr	Youngstown	580
WDLB		Marshfield	Don Trelford	Scarborough	538
WIGM		Medford	Steve Francis	Alcoa	728
WOSH		Oshkosh	Esa Hänninen	Winnipeg	3968
KIML	WY	Gillette	Gene Allen	Vallejo	985
KUGR		Green River	Olle Alm	Abisko	4390
KOJO		Laramie	Niel Wolfish	Winnipeg	708
KGOS		Torrington	Shawn Axelrod	Winnipeg	614
WMDD	PR	Fajardo	Hank Holbrook	Chevy Chase	1600
CJPR	AB	Blairemore	Esa Hänninen	Winnipeg	4053
CBXY		Fahler	Esa Hänninen	Winnipeg	3631
CFWB	BC	Campbell River	Esa Hänninen	Winnipeg	4102
CKGO		Hope	Roy Millar	Marysville	135
CBXN		Natal	Roy Millar	Marysville	375
CKOOL		Oliver	Tim Hall	Banff, AB	227
CKMV	NB	Grand Sault	Christian DeHaes	Chicoutimi	182
VOHF	NF	Harmon Field	Rodney Valdrón	Petit Rocher	410
CBDQ		Labrador City	Esa Hänninen	Winnipeg	2968
CBDJ	NT	Hay River	Esa Hänninen	Winnipeg	3281
CKEN	NS	Kentville	UK DXPedition £	Sheigra, Scotland	2591
CKAD		Middleton	Chris Lucas	Troy, NY	495
CHVR	ON	Arnprior	Shawn Axelrod	Orleans, ON	210
CHUC		Cobourg	Shawn Axelrod	Winnipeg	1027
CKEF		Ear Falls	Niel Wolfish	Winnipeg	227
CHYM		Kitchener	John Wilkins	West Des Moines	691
CFRC		Kingston	Don Voorhies	Oswego	54
CFPS		Port Elgin	Shawn Axelrod	Winnipeg	871
CKLR	PQ	L'Annonciation	Charles Reh	Leamington	490
CKBM		Montmagny	Russ Edmunds	Little Silver	493
CJMC		Ste-Anne-des-Monts	Esa Hänninen	Espoo, Finland	3810
CJSN	SK	Shaunavon	Esa Hänninen	Winnipeg	3930
XERO	AGUA	Aguascalientas	Tim Hall	40mi W of Puerto Vallarta	226
XEGT	MICH	Zamora	Tim Hall	10mi W of Mazatlan, SIN	361
XEDR	SON	Guaymas	Tim Hall	Poway, CA	503
XEMS	TAM	Matamoros	Esa Hänninen	Winnipeg	5321
HJZB	COL	Tulua	UK DXPedition £	Sheigra	5298
YVRP	VEN	Maracaibo	UK DXPedition £	Sheigra	4747

£ = UK DXPedition [Steve Whitt, Mark Hattam, Clive Rooms]



## AM Station Map Book, 2nd ed.

### \$8.00, postpaid.

Edited by DDXD editor Bill Hale, this book of station location maps is a companion to the *AM Radio Log*. Now easier to read than ever, the 170-page book is three-hole punched for a ring binder. Data is accurate as of 2-1-93, and updates of individual pages will be available at a nominal cost when a sufficient number of changes have occurred. Order from NRC Publications - Box 164 - Mannsville, NY 13661. NY orders, please add sales tax.



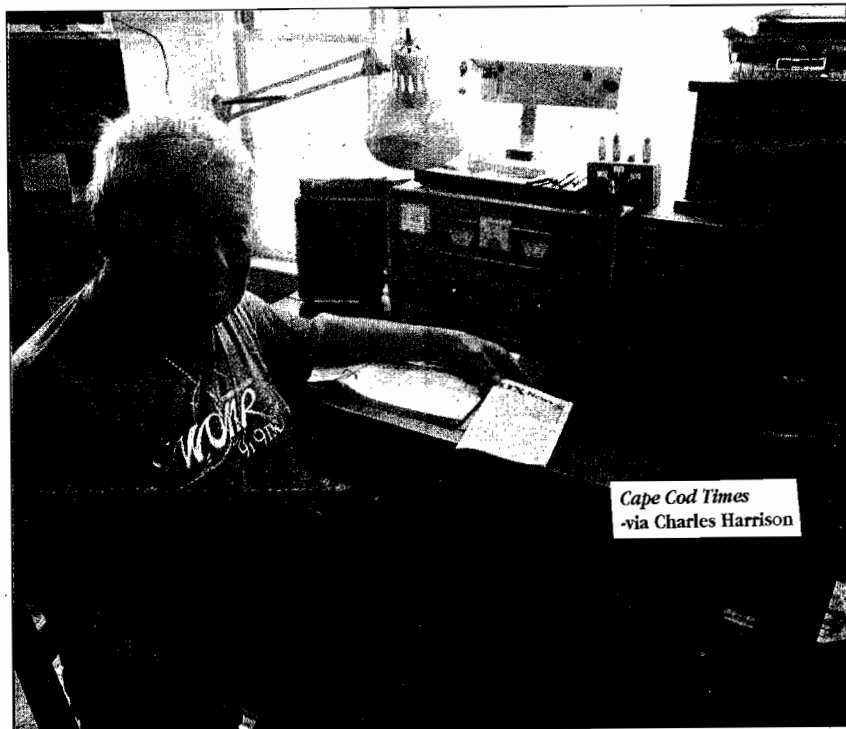

Ernest Cooper and his radios in his Provincetown home.

## Radio fan listens in to the world

By K.C. MYERS  
SPECIAL WRITER

**P**ROVINCETOWN — For the past 61 years, Ernest Cooper has been awake at 2 a.m.

He is not an insomniac, and his nightly forays have not led to the refrigerator. His insatiable desire is not for calories, but for the sounds of distant places.

Ernest Cooper is a radio addict — his machines, which bring in stations from across the nation and around the globe, have tempted him out of bed in the wee hours nearly every night of his life.

In Provincetown, his home of 18 years, he is drawn nightly to his two hulking Hammarlund radios, which occupy the better half of his living room. One built in the 1950s and the other in 1963, these massive machines can pick up AM stations as far away as Estonia. On the FM dial, Cooper has heard a radio program in Colorado. His second-hand Hammarlunds use tubes instead of transistors. Cooper says he prefers the older radios because they're easier to adjust if a frequency is off. But his collection of old photographs, yard-sale antiques, marching band and classical albums suggests that Cooper just likes old things, period.

Take his radio hobby, for example. It's called DXing, a name that comes from algebra, the "D" standing for "distance" and the "X" for a given number. It was popular in the 1930s and '40s when, Cooper says,

"people with their first radios were just thrilled to get stations out of town."

Today, there are about 800 members in the National Radio Club of America, the oldest DX club in the United States, founded in 1933, the same year 14-year-old Cooper began seriously DXing. Two other, smaller clubs have a couple hundred members apiece. Cooper belongs to all three.

For him, it's something of a family tradition.

Cooper's father used to tiptoe through their Brooklyn apartment at 1 a.m. to his old Stewart-Warner, where he'd listen for stations far beyond the New York area. His young son, Ernest, was allowed to stay up with him occasionally, when there was no school or church in the morning.

At that time, Cooper says, even with the primitive equipment, it was possible to tune in to stations all over the country because the air waves weren't occupied at night. Most radio stations shut down at midnight, so the few that stayed on had the freedom to roam without being cut off by another, more powerful wave.

"My father was always trying to get California," says Cooper, 75. "Right after he died, when I was 12, I got KFI in Los Angeles with his radio."

Cooper says he picked up a latin music station in Buenos Aires in 1938. During World War II, he tuned in to Morocco. He also has letters of verification ("veries," as DXers call them) from Saudi Arabia, Turkey, Hawaii, Estonia, "quite a few European stations" and every state in the union except Alaska.

"I was very against Alaska becoming the 49th state because I wanted to say I'd heard from every state in the U.S.," says Cooper. "I've just never been able to get Alaska."

These days, most stations keep going 24 hours, to the disappointment of DXers all over the world.

"I don't know why all these stations are on all night," says Cooper. "Who listens to them?"

DXing may be fading as a national interest, but radios are still fascinating to Cooper. He's not intrigued by the technical end, mind you — Cooper still doesn't know how to fix a radio — but rather by the machine's ability to connect with faraway places.

"I don't know why. I've been doing it all my life and it's still very exciting to me," he says. "Maybe I'm crazy."

His partner of 34 years, Bob Stinger, thinks Cooper might be onto something there. When asked how he felt about his roommate waking up at 1 every morning and returning to bed at 3, he says, "If you want an honest answer, I better not say anything."

"He thinks I'm cuckoo," said Cooper. "I go to a convention of the National Radio Club of America every year, and one year I took Bob. I thought he was going to be bored to tears. But I found him by the pool in our hotel surrounded by women. There was this swingers convention there at the same time. I think they thought he was one of them. They were filling him with booze, and he was having the time of his life."

So is Cooper, who also broadcasts a marching-band music show on WOMR-FM in Provincetown, a station he helped found.

"It's the mystery," he says of his DXing hobby, shunning any notion that it might be a sentimental attachment to the past. "It's not knowing what I'm going to hear next that I really like."

## Professional Sports Networks

Barry S. Finkel

10314 S. Oakley

Chicago, IL 60643-2409

Network listings for team sports stations

Here is Major League Baseball network information. It came from Bob Galerstein, Bill Hardy, Todd Brandenburg, Ken Onyschuk, Bob Gilfert, WJR-MI, and the Astros.

There are a few lists that I am missing; if you have them, please send them to me. Ken Onyschuk sent me some Minor League information; that will come in the next column. Note that these network lists are not "final" lists, as stations may be added to lists or be removed from lists. Also, various sources of each list often do not agree on the stations that comprise each network. The footnotes follow the entire list.

### Baltimore Orioles 1993

800 WCHA-PA  
910 WSBA-PA  
920 WPTX-MD  
930 WFMD-MD  
960 WLVW-MD

Jon Miller, Fred Manfra, Chuck Thompson  
(via Bob Galerstein)

1260 WNRK-DE  
1430 WNAV-MD  
1450 WTBO-MD  
1490 WLPB-PA 0  
1500 WTOP-DC  
1590 WETT-MD  
1700 WJTV-PA  
1740 WTRR-MD  
1490 WARK-MD 106.3 WCEM-MD

### Boston Red Sox 1993 (EE)

550 WDEV-VT  
560 WHYN-MA  
580 WTAG-MA  
600 WFST-ME g  
610 WGIR-NH  
630 WPRO-RI  
680 WRKO-MA \*  
730 WJTO-ME  
800 WLAD-CT  
860 WSBS-MA g  
870 WLAM-ME  
910 WFNS-FL h  
WABI-ME

Joe Castiglione, Jerry Trupiano

(via Bob Galerstein)  
1280 WABK-ME  
1290 WKNE-NH  
1320 WWWT-VT g  
1340 WHGS-ME h  
1350 WJTV-CT  
1370 WDEA-ME  
1380 WKTJ-ME  
1400 WILI-CT  
WIDE-ME  
WTSL-NH  
WLTN-NH  
1400 WHMP-MA  
1420 WLIS-CT  
1490 WFSM-MA  
WBEC-MA h 92.7 WQDY-ME ha  
1450 WKXL-NH  
1450 WKXL-NH  
WTOA-VT g 95.9 WUPE-MA g  
1470 WKZN-ME  
1480 WSAR-MA  
1490 WMRC-MA  
100.1 WQVR-MA ha  
100.7 WTBM-ME  
101.9 WCIB-MA  
102.3 WKXL-NH ha  
102.5 WQSS-ME  
103.1 WDME-ME h

### Boston Red Sox 1993 (SS)

950 WROL-MA w\*

Hector Martinez, Bobby Serrano

(via Bob Galerstein)  
99.5 WSSH-MA n

### California Angels 1993 (EE)

590 KRSO-CA  
710 KMPC-CA \*  
1080 KWAI-HI

Bob Starr, Billy Sample

(via Bill Hardy and Martin Foltz)  
1230 KPRL-CA  
1250 KLAU-NV  
1250 KDHI-CA  
1340 KIKO-AZ  
KGLW-CA  
KIST-CA  
1350 KBID-CA  
1360 KNNS-AZ M  
1380 KHJJ-CA  
1400 KTUC-AZ  
1430 KAMP-CA

### California Angels 1993 (SS)

1090 XEPRS-BC \*

Ulpiano Cos Villa, Ruben Valentine

### Chicago White Sox 1993 (EE)

670 WMAQ-IL \*  
860 WGOM-IN  
880 WINU-IL  
980 WITY-IL E  
1050 WTCA-IN F  
1220 WQSA-FL

John Rooney, Ed Farmer

(via Ken Onyschuk and Bob Galerstein)  
1240 WTAX-IL E  
1270 WEIC-IL E  
1320 WKAN-IL  
1330 WRAM-IL F  
1450 WLYV-IN F  
1490 WZOE-IL  
1520 WLUV-IL E  
1550 WJIL-IL F  
1570 WTAY-IL E  
WIFF-IN  
1580 WAMJ-IN  
95.1 WZZT-IL  
96.7 WLUV-IL E  
97.7 WFRX-IL F  
WMOI-IL F  
WLQI-IN  
98.3 WBYS-IL E  
101.7 WTAY-IL E  
104.9 WGEN-IL Q  
105.5 WDNB-IL  
107.7 WMRS-IN  
98.1 WIBN-IN

**Milwaukee Brewers 1993**

550 WSAU-WI	1090 WISS-WI
570 WMAM-WI	1150 WHBY-WI
580 WKTY-WI	1230 WIKB-MI
590 WJMS-MI	WCLO-WI
620 WTMJ-WI *	1240 WOMT-WI
680 WDBC-MI	WOBT-WI
910 WDOR-WI	WJMC-WI g
940 WFAW-WI	1260 WWIS-WI
960 WTCH-WI	WEKZ-WI
970 KXTP-WI	1270 WRJC-WI h
980 WPRE-WI	1290 WCOW-WI g
1010 WSPQ-WI	1310 WIBA-WI
1050 WLIP-WI	1320 WFHR-WI

**Bob Uecker, Pat Hughes**

(via Bill Hardy and Bob Galerstein)

1330 WHBL-WI	1550 WMIR-WI	96.3 WJMC-WI
1340 WLDY-WI	WEVR-WI	96.7 WJJH-WI
1380 WBEL-IL	1590 WTOQ-WI	97.1 WCOW-WI g
1400 WDUZ-WI		98.3 WCQM-WI
	92.1 WRLS-WI	99.1 WIKB-MI
	92.3 WJPD-MI h	99.3 WIGM-WI
	92.7 WDXJ-WI q	WOWN-WI
	99.7 WWIS-WI h	
1430 WRDN-WI	93.7 WEKZ-WI	100.1 WDDC-WI
	93.9 WDOR-WI	100.9 WRCO-WI
1450 WDLB-WI	94.3 WPRE-WI	102.3 WISS-WI
	94.5 WRJO-WI	105.3 WRLO-WI
	95.9 WRDN-WI	106.3 WEVR-WI

**Minnesota Twins 1993**

610 KDAL-MN	1060 KGFX-SD
660 KEYZ-ND	1140 KS00-SD
730 KWOA-MN	1170 KOWO-MN
790 KFGO-ND	1190 KWMB-MN
800 KQAD-MN	1230 KWNO-MN
830 WCCO-MN *	KGHS-MN
860 KNUJ-MN	KTRF-MN
910 KJJQ-SD	1240 WJON-MN
920 KWAD-MN	KDLR-ND
930 KKIN-MN	1260 KROX-MN
	1270 KLXX-ND
950 KWAT-SD	1290 KSCR-MN
980 KDSJ-SD	1300 KGLO-IA
1050 WISM-WI	1310 KNOX-ND
1060 KFIL-MN	1320 KOZY-MN

**Herb Carneal, John Gordon**

(via Bill Hardy and Bob Galerstein)

1340 KROC-MN	1410 KHOL-ND	92.1 KOWO-MN
	1420 KTOE-MN	WYRQ-MN
	1450 KBMW-MN	92.5 KKWQ-MN
		93.5 KSCR-MN
		94.3 KDOM-MN
		96.5 KJJK-MN
		101.7 KOLV-MN
		102.5 KQLW-MN
		102.9 KBWS-SD
		103.1 KFIL-MN
		105.5 KMGM-MN x
		105.9 KMIT-SD
		106.1 KQLX-ND
		106.3 KRJB-MN

**Oakland Athletics 1993**

570 KCNO-CA	980 KINS-CA
580 KCMX-OR	990 KKIS-CA
910 KNEW-CA *	1080 KSCO-CA h
950 KAHJ-CA	1270 KXBX-CA
970 KBEE-CA	1280 KJAX-CA

**Bill King, Lon Simmons, Ray Fosse**

(via Bill Hardy and Bob Galerstein)

1300 KPMO-CA	1400 KUKI-CA	1450 KVML-CA
1320 KCTC-CA	KIXT-CA	KOZZ-NV
1340 KNKTR-CA h	KQMS-CA	1480 KYOS-CA
	KBOS-CA g	1410 KMYC-CA
	1360 KNNS-AZ hm	1450 KTIIP-CA
		KBLF-CA

**Seattle Mariners 1993**

550 KENT-AK w	840 KDBS-OR
600 CHRX-BC p	870 KORD-WA
650 KQQQ-WA A	920 KXLY-WA
680 KOMM-WA w	990 KRKT-OR
710 KIRO-WA *	1030 KMAS-WA
730 KULE-WA	1150 KQQQ-WA A
800 KINY-AK p	1170 KPUG-WA

**Ron Fairly, Dave Niehaus**

(via Bill Hardy and Bob Galerstein)

1240 KWIK-ID p	1340 KWWW-WA	1550 KVAN-WA
	KCVL-WA	KLKI-WA
	KXLE-WA	1360 KUIK-OR
	95.9 KULE-WA	
	96.7 KREW-WA	
	97.1 KNSN-WA	
	100.7 KIRO-WA s	

**Texas Rangers 1993 (EE)**

600 KTBB-TX	790 KFYO-TX
610 KARV-AR	820 WBAP-TX *
620 KWFT-TX	920 KTOC-LA
640 WWLS-OK	1070 WKII-FL
690 KPET-TX	1150 WTAW-TX G
710 KGNC-TX	1230 KSST-TX
740 KCMC-TX	1260 KTUE-TX

**Mark Holtz, Eric Nadel**

(via Bill Hardy)

1280 WQUE-LA G	1440 KEYS-TX	92.7 KTOD-AR P
1290 KIVY-TX	1450 KGFF-OK	93.7 KSPT-OK
1320 KXOL-OK	1470 KNTS-TX	98.3 KCUB-TX
1330 KFCA-AR K	1530 KXTD-OK	105.3 KHOX-AR G
1340 KCAT-AR	1590 KGAS-TX	
1370 KFRO-TX		
1400 KVOP-TX	92.3 KCUL-TX	

**Chicago White Sox 1993 (SS)**

560 WIND-IL \*p

910 WBRJ-OH	1260 WRIE-PA
920 WMNT-OH	1340 WSTV-OH
930 WEOL-OH	1370 WSPD-OH
960 WKVX-OH	1400 WMAN-OH
970 WFUN-OH	1410 WDOE-NY
1220 WKNR-OH *	1430 WCLT-OH

**Chico Carrasquel**

1430 WFOB-OH	1510 WVAC-OH hl
1450 WJER-OH	WLKR-OH g
1460 WBKC-OH	1520 WBNX-OH g
1470 WRQQ-PA	1540 WBTC-OH h
1480 WHBC-OH	1550 WDLR-OH
1490 WMRN-OH	1590 WAKR-OH

**Cleveland Indians (1/21/93)**

**Herb Score, Tom Hamilton**

(via Bob Galerstein)

920 WMNT-OH	1340 WSTV-OH	1450 WJER-OH	1510 WVAC-OH hl
930 WEOL-OH	1370 WSPD-OH	1460 WBKC-OH	1520 WBNX-OH g
960 WKVX-OH	1400 WMAN-OH	1470 WRQQ-PA	1540 WBTC-OH h
970 WFUN-OH	1410 WDOE-NY	1480 WHBC-OH	1550 WDLR-OH
1220 WKNR-OH *	1430 WCLT-OH	1490 WMRN-OH	1590 WAKR-OH

**Detroit Tigers 1993**

**Rick Rizzs, Bob Rathbun, Ernie Harwell**

(via Bill Hardy and WJR-MI)

580 WTCM-MI	1230 WCUZ-MI	1380 WPLB-MI	1460 WBRN-MI	97.7 WMRX-MI
590 WKZO-MI	WSOO-MI	1400 WCCY-MI	1490 WMPX-MI	98.3 WCSY-MI
760 WJR -MI *	1240 WCBY-MI		WTIQ-MI	WHCH-MI
790 WSGW-MI	WJIM-MI	1430 WION-MI	WSTP-NC	100.1 WSHN-MI
850 WKBZ-MI	1280 WFCY-MI	1450 WNBV-MI		100.9 WBRN-MI
900 WSNQ-MI	1320 WDMJ-MI		WHTC-MI	104.3 WCZY-MI
930 WBECK-MI	1340 WMBN-MI		WATZ-MI	104.7 WYXX-MI
1050 WTKA-MI	1360 WHNR-FL		WKLA-MI	95.3 WMJZ-MI

**Kansas City Royals 1993**

**Denny Mathews, Fred White**

(via Todd Brandenburg (KC Star 4/4/93) and Bill Hardy)

560 KWTO-MO	1240 KNEM-MO	1430 KKOZ-MO	1580 KNIM-MO	96.7 KANS-KS i
580 WIBW-KS *	KFOR-NE	1440 KCHE-IA	1590 KVG6-KS	97.7 KAYQ-MO
610 WDAF-MO	1270 KSCB-NE	1450 KWBW-KS	1600 KMDO-KS	KNCY-NE
620 KMNS-IA	KTRT-OK	1470 KERE-KS	KTTN-MO	98.7 KSPG-KS jf
680 KFEQ-MO	1280 KSOK-KS	1480 KZSN-KS	KNCY-NE	99.3 KNIM-MO j
690 KGGF-KS	1290 KLEH-IA	1490 KXLQ-IA	KOKO-MO	KUTT-NE
750 KJEL-MO	KWLS-KS	1490 KXLM-MO	KDMO-MO	92.1 KCHE-IA
790 KXXX-KS	KOIL-NE	1510 KANS-KS	KDRO-MO	99.9 KBFL-MO v
860 KKOW-KS	1300 KMMO-MO	KAWL-NE	KTTR-MO	KMZA-KS
880 KRVN-NE	1310 KGMT-NE	1460 KKOY-KS	1470 KERE-KS	KTTN-MO
960 KMA -IA	1330 KFCA-AR yk	1480 KZSN-KS	1490 KXLM-MO	100.3 KCLY-KS
	KNEB-NE	1340 KGFV-NE	1530 KMAM-MO	100.9 KQLS-KS
	990 WCAZ-IL	1350 KMAN-KS	1540 KNGL-KS	92.3 KBUG-MO
	KRSL-KS	1360 KSRX-KS f	1540 KNGL-KS	101.7 KINF-KS
	KRMO-MO	1370 KSPG-KS i	1540 KNGL-KS	92.3 KBUG-MO
1010 KCHI-MO	1370 KGN0-KS	1490 KXLM-MO	1540 KNGL-KS	101.7 KINF-KS
1060 KNLV-NE	KAWL-NE	1510 KANS-KS	1540 KNGL-KS	92.7 KTOD-AR jy102.9 KMNO-MO
1150 KWKY-IA	1390 KNCK-KS	KMRF-MO	1540 KNGL-KS	KIDA-IA i 103.1 KNDY-KS
	KRMS-MO	1400 KAYS-KS	1530 KMAM-MO	93.1 KYOO-MO jr103.7 KIRK-MO
	KSAL-KS	KBZZ-CO i	1540 KNGL-KS	93.5 KLKC-KS
1190 KVSU-KS	KVOE-KS	1540 KNGL-KS	1540 KNGL-KS	103.9 KOMB-KS
1200 KYOO-MO	1420 KJCK-KS	1550 KKLE-KS	1540 KNGL-KS	KCHI-MO
1220 KOMC-MO	KBTN-MO	1570 KLEX-MO	1540 KNGL-KS	94.3 KZMO-MO
1230 KTNC-NE	KULY-KS	1580 KTGR-MO	1540 KNGL-KS	94.5 KEZU-KS cj
1240 KIUL-KS	KZMO-MO	KESM-MO	1540 KNGL-KS	95.3 KCKS-KS

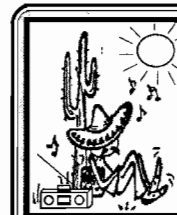

**"Latin America on the Air"**

60 minutes of air checks from Latin America and the Caribbean, 23 countries including most of South America, the Falkland Islands, and more, in a storage case. Order DXC/4, for \$7.50, from NRC Publications; NY orders, please add sales tax.

**Texas Rangers 1993 (SS)**  
910 KXEB-TX \*

Jorge Infante, Mario Montez

**Toronto Blue Jays 1993**

Tom Cheek, Jerry Howarth  
(via Bill Hardy and Bob Galerstein)

560 CFOS-ON	910 CKLY-ON	1190 CFSL-SK	1340 CKNR-ON	1570 CFOR-ON
580 CKWW-ON	930 CKNS-ON	1230 CKMP-ON	1350 CKEG-BC	1600 CHNR-ON
710 CJRN-ON	950 CKBB-ON	1240 CJCS-ON	CKAR-ON	
730 CJNR-ON	960 CFFX-ON	CJRW-PE	1400 CKCB-ON	94.9 CKPE-NS
750 CKGB-ON	1050 CFYN-ON	1270 CJTN-ON	1430 CJCL-ON *	96.7 CKGL-ON
790 CIGM-ON	1070 CHOK-ON	1280 CJSL-SK	1450 CHUC-ON	100.9 CFBG-ON
880 CKLQ-MB	1130 CKWX-BC	1290 CJBK-ON	1490 CFP5-ON	101.1 CHEQ-ON
900 CHML-ON	1140 CFXX-AB	1320 CJMR-ON	1570 CKMW-MB	101.9 CKAT-ON

**New York Yankees 1993**

John Sterling, Michael Kay  
(I do not have the Yankees' list.)

770 WABC-NY \*

**Atlanta Braves 1993**

Skip Caray, Pete Van Wieren, Joe Simpson  
(via Bill Hardy)

540 WDXN-TN	1160 WAMB-TN	1340 WTIF-GA	1450 WKEU-GA	94.9 WMKO-GA
550 WDUN-GA	1170 WHNE-GA	1350 WGAD-AL	WGPC-GA	95.3 WTGA-GA
580 WGAC-GA	1230 WBHP-AL	1360 WMFC-AL	WVLD-GA	WYSC-GA
	WMGA-GA	WYAX-GA	WCHL-NC	WTAL-FL
590 WCAB-NC	WBLJ-GA	WZPQ-AL	1460 WBCU-SC	95.9 WKXN-AL m
610 WCEH-GA	WFAI-NC	1370 WCOA-FL	1470 WRGA-GA	96.7 WMKJ-GA
	WASKY-NC	WLOP-GA o	WCLA-GA	WVMG-GA
630 WAVU-AL	WGGG-FL	1380 WGYV-AL m	1480 WAJA-NC	97.7 WKLD-AL
640 WGST-GA *	1240 WBGC-FL	WTOB-NC	1490 WHBB-AL	WISK-GA C
690 WJOX-AL	WWNS-GA	WLRV-VA	WRLD-GA	97.9 WDMT-AL
710 WKRG-VA	WAVN-MS	1390 WXTX-SC	WLOE-NC	98.3 WWT-SC
	WFNR-AL	1400 WTXQ-AL	WSVM-NC	WINJ-TN
730 WOHS-NC	WBHB-GA	WAVD-AL	WGCD-SC	98.7 WISK-GA C
	WLAG-GA	WWRK-GA	WSNT-GA	99.1 WBAW-SC
740 WBAW-SC	WPAX-GA	WCOS-SC	WCHM-GA	99.3 WMFC-AL
790 WQSV-TN	1270 WLIK-TN	WJHO-AL	WSFB-GA	99.9 WACQ-AL
800 WJAT-GA	1280 WPID-AL	WNUE-FL	1520 WKVQ-GA	100.7 WBNK-VA
830 WWMO-NC	WSAT-NC	WCOH-GA	WNWS-TN	100.9 WIFM-NC
860 WDMG-GA	1290 WCHK-GA	1410 WEGO-NC	1560 WCCP-SC k	101.9 WHHY-AL
900 WJTH-GA	WATO-TN	1420 WACT-AL	1570 WCRL-AL	WSGC-GA
910 WORD-SC	WCHY-GA	WRCG-GA	1590 WVNA-AL	102.3 WQTU-GA
	WJCW-TN	1300 WMTN-TN	WPEH-GA	102.9 WMJE-GA
	WEPG-TN	1310 WHEP-AL	WMYN-NC	103.1 WRIX-SC
	WRNL-VA	WTIK-NC	WKSJ-TN	103.5 WMTY-SC
930 WSLI-MS	WGH -VA J	1430 WLTG-FL	103.9 WQLS-AL	
	WLLL-VA	WADC-FL	92.1 WKUL-AL	WDDK-GA
940 WMAZ-GA	1320 WGLD-NC	1440 WHHY-AL	WBTR-GA	104.5 WGPC-GA
950 WGTA-GA	1330 WMLT-GA	WLNK-NC	WWRK-GA	104.9 WCCP-SC k
970 WVOP-GA	WVFB-SC	WVMG-GA	WPEH-GA	105.5 WIFO-GA o
	WWIT-NC	1340 WFEB-AL	1450 WDLK-AL	92.5 WOKF-GA
	WPGA-GA	WGAA-GA	WMVG-GA	92.7 WLIQ-TN
	WBZK-SC	WBGK-KY	WGNK-NC	92.9 WZLA-SC
990 WEIS-AL	WKRK-TN	WHSC-SC	93.5 WLIL-TN	106.7 WAMB-TN d
1050 WWIC-AL	WBAC-TN	WGNS-TN	94.3 WPUB-SC	107.1 WCLA-GA
1130 WACQ-AL	WGAU-GA	WDNG-AL	WIST-TN B	
1150 WGOV-TN	WHAP-VA	WBHF-GA	94.5 WIST-TN B	

**Chicago Cubs 1993**  
Ron Santo

570 KNAX-SD	1290 WIRL-IL
720 WGN -IL *	1310 KOKX-IA I
740 WLWI-AL D	WGH -VA J
910 WAKO-IL	1320 WNGO-KY
920 WMOK-IL	1330 WRAM-IL F
930 WHON-IN	1350 KRNT-IA
960 WSBT-IN	1370 KDTH-IA
1020 WCIL-IL	1380 KCIM-IA
1050 WDZ -IL	1400 WBAT-IN
	WTCA-IN F
1060 WRHL-IL	KADR-IA
1150 KCKY-AZ	WDWS-IL I
1250 KCFI-IA	1410 WGRD-MI
	1440 WGEM-IL

Harry Caray, Steve Stone, Thom Brennaman,

		(via Bob Galerstein)	
1450 WLYV-IN F	1550 KIWA-IA	97.7 WFRX-IL F	
	WFMB-IL	98.5 WXXQ-IL	
1460 WKAM-IN	1560 WIFF-IN	102.3 WRHL-IL	
	KENO-NV N	103.1 WAKO-IL	
1470 WQSN-MI	1590 WPCO-IN	104.9 WAXI-IN	
	WHUT-IN	WGEN-IL Q	
1480 WRSW-IN	1600 KCRG-IA	105.5 KIWA-IA	
	WDAN-IL	107.1 WBNL-IN	
1500 WGEN-IL I	94.3 WJNZ-IN	107.3 WRSW-IN	
	95.9 WKUZ-IN		
1510 WINU-IL	96.9 WLBH-IL		
	1540 WBNL-IN		
	97.5 WDWS-IL		
1550 WJIL-IL F	97.7 WMOI-IL F		

**Cincinnati Redlegs 1993**

560 WJLS-WV	1240 WHIZ-OH
580 WCHS-WV	1250 WOFR-OH
610 WTVN-OH	1260 WNDI-IN
620 WDNC-NC	1290 WHIO-OH
680 WCTT-KY	WVOW-WV
700 WLW -OH *	1300 WLXG-KY
740 WLWI-AL D	1320 WLOH-OH
	WRNR-WV
920 WTCW-KY	WYPC-OH
930 WTKZ-WV	1340 WLBC-IN
970 WATH-OH	1370 WGOH-KY
990 WJEH-OH	1380 WHRS-KY
1050 WGAT-VA	1390 WBLI-OH
1150 WIMA-OH	1400 WPAY-OH
1230 WIRO-OH	WVRC-WV
1240 WFTM-KY	WBTH-WV
	WSFC-KY
	1440 WPGW-IN

Marty Brennaman, Joe Nuxhall

		(via Bill Hardy)	
1440 WMDJ-KY	92.7 WCMI-KY	103.9 WRBI-IN	
	WRRO-OH	WIMC-IN	
1450 WXVW-IN	94.1 WAXS-WV	WXKQ-KY	
1490 WKWB-IN	94.3 WRCR-IN	104.1 WLBC-IN	
	WFKY-KY	WPAY-OH	
	WBEX-OH	104.9 WWVY-IN	
	WJOC-TN	95.9 WFTM-KY	
	WOMI-KY	96.7 WKOV-OH	
	WSIP-KY	WBVI-OH	105.1 WRNZ-KY
	1520 W000-IN	99.5 WBKW-WV t	105.5 WSWV-VA
	1550 WNDI-IN	100.1 WMDJ-KY	105.9 WHAY-KY
	WCVL-IN	100.9 WPGW-IN	106.1 WRZZ-WV
	1570 WSWV-VA	101.5 WMMG-OH	106.7 WSRW-OH
	1590 WSRW-OH	101.7 WMCQ-KY	107.3 WCTT-KY
	1600 WBLV-OH	101.9 WVOW-WV	107.5 WZLK-KY
		102.3 WFPC-IN	
	92.1 WMP0-OH	WUGO-KY	

**Colorado Rockies 1993**

850 KOA -CO \*

Wayne Hagin, Jeff Kingery  
(I do not have the Rockies' list.)

**Florida Marlins 1993**  
Galerstein)

540 WGTO-FL	600 WOKV-FL
560 WQAM-FL *	1130 WBBF-FL
590 WGNE-FL	1200 WDCQ-FL

Joe Angel, Dave O'Brien

1230 WJNO-FL	1350 WLMA-SC
1240 WFOY-FL	1380 WELE-FL
1330 WJNX-FL	1500 WKIZ-FL
	99.3 WLRQ-FL

**Houston Astros 1993 (EE)**  
Cotroneo, Bill Brown

560 KLVI-TX	1230 KERV-TX
580 KALB-LA	KSIX-TX
710 KURV-TX	1250 KZEP-TX
790 KKYR-AR	1260 KXQZ-TX
860 KSFA-TX	1280 WQUE-LA G
910 KNAF-TX	KWHI-TX
930 KDET-TX	1300 WIBR-LA
950 KPRC-TX *	KFLO-LA
1080 WFIV-FL	KVET-TX
1150 WTAW-TX G	1330 KFCA-AR K

Milo Hamilton, Larry Dierker, Vince

		(via Bill Hardy and the Astros)	
1330 KDOK-TX	1450 KCTI-TX	92.7 KIVY-TX	
1340 KAMG-TX	1460 WACO-TX	94.7 KVLL-TX	
	KRBA-TX	98.3 KULM-TX	
1350 KTXJ-TX	1470 KLCL-LA	98.5 KRXT-TX	
	KUOL-TX	102.3 KDET-TX	
1400 KEBE-TX	1490 KVLL-TX	105.3 KHGX-AR G	
	KTEM-TX	106.3 KPJN-TX	
	1520 KRJH-TX		
1440 KMLB-LA	92.7 KTD0-AR P		

**Houston Astros 1993 (SS)**

1320 KXYZ-TX \* 1530 KGBT-TX

Ernesto Ruiz, Manny Lopez (via Bill Hardy)



NRC members are invited to join us for a weekend of fun at the 1993 WTFDA Convention! Send an SASE for convention information to Tom Bryant - 849 Todd Preis Drive - Nashville, TN 37221. Convention HQ is Days Inn Central - 211 North First St. - Nashville, TN 37213 (800-251-3038; mention "DX" for convention rate); the room rate is \$45 for 1-4 occupancy (guaranteed through June 15). Advance registration is \$25; at the door, \$30. We'll be looking for you!



**Los Angeles Dodgers 1993 (EE)** Vin Scully, Don Drysdale, Ross Porter  
(via Bob Galerstein and Martin Foltz)

610 KAVL-CA	920 KVEC-CA	1240 KJAA-AZ	1340 WSTA-VI p	1560 KNZR-CA
690 KVNA-AZ e	950 KNFT-NM	KLOA-CA	1370 WAXE-FL p	1570 KUAU-HI p
720 KDWN-NV	990 KTKT-AZ	1250 KTMS-CA	1400 KEYX-CA	
760 KGU -HI *	1140 KCMJ-CA	1300 KRQP-CA	1440 KUHL-CA	92.7 KAKT-CA
790 KABC-CA *	1230 KBOV-CA	1310 KIQQ-CA	1450 KVEN-CA	
910 KVVQ-CA	KYVA-NM p	1320 KHSJ-CA	KMSL-MT p	

**Los Angeles Dodgers 1993 (SS)** Jaime Jarrin, Rene Cardinas  
(via Bob Galerstein and Martin Foltz)

910 KOXR-CA	1010 KCHJ-CA	1280 KDOL-NV	1330 KWKW-CA *	1490 KICO-CA
-------------	--------------	--------------	----------------	--------------

**Montreal Expos 1993 (EE)** Dave Van Horne, Ken Singleton, Elliott Price

600 CIQC-PQ \* (I do not have the Expos' English list.)

**Montreal Expos 1993 (FF)** Jacques Doucet, Rodger Broulette, Alain Chantelois

730 CKAC-PQ \* (I do not have the Expos' French list.)



**New York Mets 1993 (EE)** Bob Murphy, Gary Cohen  
(via Bill Hardy)

660 WFAN-NY *	950 WIBX-NY	1490 WCD0-NY	1570 WFLR-NY	101.7 WRCZ-MA
870 WHCU-NY	1340 WALL-NY	1520 WWKB-NY	1590 WPSL-FL	WBAA-NY
930 WIZR-NY	1450 WKIP-NY	1540 WPTR-NY		

**New York Mets 1993 (SS)** Billy Berroq, Armand Talavera, Juan Alicea, Renato Morffi

620 WSKQ-NY \*

**Philadelphia Phillies 1993** Harry Kalas, Chris Wheeler, Andy Messer, Richie Ashburn  
(via Bob Galerstein)

590 WARM-PA	1210 WOGL-PA *	1270 WLBR-PA	1390 WRSC-PA	1490 WAZL-PA
790 WAEB-PA	1230 WCNC-NJ	1320 WGET-PA	1400 WOND-NJ	WNBT-PA
850 WEEU-PA	WPBZ-PA	1350 WOYK-PA L	WRAK-PA	WLPA-PA O
960 WPMR-PA	WKBO-PA	1360 WPPA-PA	1420 WCOJ-PA	
1150 WDEL-DE	1240 WYGL-PA	1390 WKLP-WV	1440 WREY-NJ	105.5 WCHX-PA

**Pittsburgh Pirates 1993** Lanny Frattare, Jim Rooker, Kent Derdivanis, Steve Blass  
(via Bob Galerstein)

590 WMBS-PA	1230 WTIV-PA g	1400 WKBI-PA	1480 WCNS-PA	93.5 WBNV-OH
600 WFRM-PA	1250 WMSG-MD g	WJRV-PA h	1490 WOHI-OH	94.7 WELK-WV
940 WESA-PA	1270 WCBC-MD	WKWK-WV	WNTJ-PA	96.5 WVNW-PA g
990 WTIG-OH	1280 WKST-PA	1420 WBRD-FL	WMGW-PA	100.9 WRAX-PA h
WVSC-PA	1310 WNAE-PA	1430 WVAM-PA	WTCS-WV	102.1 WOWQ-PA
1000 WIOO-PA H	1330 WYEZ-PA	WEIR-WV	WESB-PA	103.1 WANB-PA
1020 KDKA-PA *	WETZ-WV	1440 WAJR-WV	1540 WECZ-PA	105.5 WPXZ-PA
1050 WMSG-MD	1340 WCVI-PA	1450 WFRA-PA	1580 WANB-PA	107.1 WEXC-PA
WADC-WV	WTRN-PA	WMAJ-PA	1590 WCBG-PA	
1150 WHUN-PA	WHAR-WV	WJPA-PA	1600 WPDC-PA	
1160 WCCS-PA	1350 WOYK-PA gL	1460 WMBA-PA		
1230 WBVP-PA g	1390 WHOT-OH	1470 WZGO-PA	92.1 WXIE-MD h	

**San Diego Padres 1993 (EE)** Ted Leitner, Bob Chandler, Jerry Coleman  
(via Bill Hardy)

660 KTNN-AZ	1230 KAAA-AZ	1230 KINO-AZ	1360 KNNS-AZ M	1460 KENO-NV N
760 KFMB-CA *	KXO -CA	1280 KKAL-CA	1450 KSGI-UT	

**San Diego Padres 1993 (SS)** Eduardo Ortega, Mano Thomas, Matias Santos

1420 XEXX-BC \*

**Saint Louis Cardinals 1993** Mike Shannon, Jack Buck  
(via Bill Hardy)

560 WHBQ-TN	1230 KBTM-AR	1430 WYMC-KY	92.9 WSEI-IL	100.7 KOKR-AR
690 KEWI-AR	WLLR-IL	KQLL-OK	93.5 WKBL-TN	100.9 KTUI-MO
740 WVLN-IL	1240 KTLO-AR	1440 WRAJ-IL	93.7 WTKB-TN	101.3 KTXR-MO
800 KVOM-AR	WENK-TN	1450 WKEI-IL	94.3 WDXR-IL	101.7 WTAY-IL E
KAGH-AR	KBIZ-IA	WDXR-KY	KQMX-MO	102.1 KJFM-MO
860 KOSE-AR	WTAX-IL E	KWPM-MO	94.5 KCLR-MO	102.3 KJPW-MO
WSON-KY	KFMO-MO	KIRX-MO	95.1 KCZE-IA	KDEX-MO
900 KHOZ-AR	KWOS-MO	WTRO-TN	KLGS-MO	KCZQ-IA
KFAL-MO	WWZQ-MS	1460 WROY-IL	95.3 KOKX-IA	WEBQ-IL
910 KAMD-AR	1250 WRAY-IN	WIXN-IL	KMAQ-IA	WRMJ-IL
940 WMIX-IL	1270 WEIC-IL E	1470 WMBD-IL	WMSK-KY	WCBL-KY
960 KZIM-MO	1310 KOKX-IA I	WNAU-MS	95.7 WCRC-IL	103.1 KLOW-MO
980 WITY-IL E	1340 KSMO-MO	1480 WTHI-IN	95.9 KSAR-AR	103.9 KPOC-AR
1050 KSIS-MO	KXEO-MO	1490 KDRS-AR	KCHA-IA	WXIS-TN
1070 KHMO-MO	KBTA-AR	1500 WGEN-IL I	KKBL-MO	104.7 WLMD-IL
1090 WCRA-IL	WJPF-IL	1520 WLUV-IL E	96.3 KHL5-AR	KRES-MO
1120 KMOX-MO *	WSOY-IL	KMPL-MO	96.7 WLUV-IL E	104.9 KAGH-AR
1130 WSJP-KY	WBIW-IN	1550 WMSK-KY	WKXQ-IL	WGEN-IL Q
1220 KJAN-IA	1360 KFFA-AR	KSFT-MO	WFML-IN	KPWB-MO
WLPO-IL	1390 KCRC-OK	1570 WTAY-IL E	KMEM-MO	105.1 WGEN-IL
1230 KCON-AR	WTJS-TN	WTRB-TN	97.5 WBBA-IL	105.3 WWZQ-MS
KWAS-MO	1400 WDWS-IL I	1580 KCHA-IA	KOEA-MO	105.5 KTEI-AR
WBBZ-OK	WGLI-IL	WBBA-IL	98.1 WRAY-IN	KILJ-IA
KFPW-AR	KFRU-MO	1590 KDEX-MO	98.3 KTLO-AR	106.3 KMIS-MO
WJBC-IL	1410 KGRN-IA		WBYS-IL E	107.1 WEAI-IL
WHCO-IL	WTIM-IL	92.7 KCZY-IA	99.3 WZLT-TN	107.9 WAMW-IN
WHOP-KY	1420 KXOW-AR	WRAJ-IL	100.1 KYFM-OK	
KLWT-MO	WINI-IL	KLOZ-MO	100.3 KGAR-MO	

**San Francisco Giants 1993** Ted Robinson, Henk Greenwald, Barry Tomkins  
(via Bob Galerstein)

600 KHTE-CA	990 KHVH-HI	1270 KJUG-CA	1360 KFIV-CA
620 KWSO-CA	1150 KAGO-OR	KPLY-CA	1380 KSMJ-CA
680 KNBR-CA *	KBAT-CA	1300 KYNO-CA	1540 KLAU-CA
730 KBOY-OR	1240 KSUE-CA	1340 KATA-CA	1560 KIQS-CA



\* Flagship station of the network

a The Red Sox list from BG has calls without frequencies; I do not know if AM or FM or both stations with the same call carry the broadcasts.

b The Red Sox list has a typo "WTLV".

c Call shown as "KEZU" by team, possible recent change from KSKL. KEZU calls shown on 104.7 in Booneville AR on 3/18/93".

d Temporary FM station because of Cuban interference to 1160 AM.

e This station is in the BG and MF lists but not in the BH list.

f Listed as "KSPG 1360 El Dorado". Could be KSRX-1360 El Dorado or KSPG-98.7 Clearwater.

g This station is in the BG list but not in the BH list.

h This station is in the BH list but not in the BG list.

i This station is in the TB list but not in the BH list.

j This station is in the BH list but not in the TB list.

k Listed as "WCCP-FM 104.9 Clemson". Could be WCCP-1560. Could be a new 104.9 outlet not shown in *M Street* or *FM Atlas* for Clemson area".

l Listed as "WLKR-AM 1510 Norwalk". Could be WVAC-1510 or WLKR-FM-95.3.

m Listed as "WKXN-FM 1380 Greenville". Could be WGYV-1380 or WKXN-95.9.

n This station broadcasts night games only.

o Listed as "WIFO-AM 1370 Jesup". Could be WLOP-1370 or WIFO-FM-105.5.

p These stations carry only a partial schedule.

q The BG list has KDUX, the BH list has WDUX.

r Listed as 106.3 by team, but *M Street* and *FM Atlas* list KYOO-FM as 93.1.

s Games air on KIRO-AM 710 except in cases of conflict, when games may air on KIRO-FM 100.7".

t Call shown as "WBKW" by team, possible recent change from WJLS-FM. WBKW calls shown on 91.5 in Dublin VA on 3/18/93.

u Call shown as "KQSM" by team, possible recent change from KKOY-FM.

- v The TB list has 101.1 for KLRK-MO; the BH list has 100.1.
- w This station broadcasts weekend games only.
- x The Twins' list has "KMGH 105 FM".
- y Listed as "KTOD 1330 Conway". Could be KFCA-1330 or KTOD-92.7.
- A KQQQ-WA will move from 1150 to 650.
- B WIST-TN will move from 94.3 to 94.5.
- C WISK-GA will move from 97.7 to 98.7.
- D This station carries Chicago Cubs and Cincinnati Redlegs.
- E These stations carry Chicago White Sox and Saint Louis Cardinals.
- F These stations carry Chicago White Sox and Chicago Cubs.
- G These stations carry Houston Astros and Texas Rangers.
- H This station carries the Orioles and the Pirates.

- I These stations carry Chicago Cubs and Saint Louis Cardinals.
- J This station carries Chicago Cubs and Atlanta Braves.
- K This station carries Houston Astros, Texas Rangers, and Kansas City Royals.
- L This station carries Pittsburgh Pirates and Pittsburgh Phillies.
- M This station carries San Diego Padres, Oakland Athletics & California Angels.
- N This station carries Chicago Cubs and San Diego Padres.
- O This station carries Baltimore Orioles and Pittsburgh Phillies.
- P This station carries Kansas City Royals, Houston Astros, and Texas Rangers.
- Q This station carries Chicago White Sox, Chicago Cubs, and Saint Louis Cardinals.

# Geomagnetic Summary

Phil Bytheway  
9705 Mary NW  
Seattle, WA 98117-2334

High "A" values indicate possible auroral conditions

## Geomagnetic Summary February 4 1993 through March 2 1993

Date	FLUX	A	K	SA	GEO	ETC
2/ 4	147	6	1	moderate	quiet	-
5	160	6	1	low	quiet	swa
6	184	2	3	high	quiet	maf/swa
7	176	18	4	low	quiet-active	swa
8	188	29	4	low	unsettled-mis	-
9	185	17	2	moderate	unsettled-active	swa
10	180	11	3	moderate	unsettled	swa
11	173	14	4	moderate	quiet-unsettled	swa
12	149	11	3	low	quiet-unsettled	swa
13	135	9	3	low	quiet-unsettled	swa
14	141	5	1	moderate	quiet	swa
15	135	1	1	low	quiet	swa
16	134	8	1	moderate	quiet-unsettled	swa
17	124	28	1	high	quiet-mis	maf/swa
18	126	12	3	moderate	quiet-active	swa
19	116	7	3	low	unsettled-quiet	swa
20	123	22	1	moderate	active-quiet	swa
21	123	17	3	low	unsettled-active	swa
22	133	18	3	low	unsettled-active	swa
23	132	6	2	low	quiet-active	swa
24	136	4	3	low	quiet	swa
25	128	6	1	low	quiet-unsettled	swa
26	126	3	0	very low	quiet	swa
27	124	2	4	very low	quiet-active	swa
2/28	124	21	1	low	quiet-active	swa
3/ 1	132	12	4	low	quiet-active	swa
3/ 2	144	15	3	high	quiet-active	maf/swa

## Geomagnetic Summary March 3 1993 through March 29 1993

Date	FLUX	A	K	SA	GEO	ETC
3/ 3	151	19	4	low	unsettled-mas	swa
4	167	20	2	moderate	quiet-active	spa/swa
5	165	5	0	low	quiet	swa
6	167	8	3	high	quiet-unsettled	maf/swa
7	153	11	3	low	quiet-unsettled	swa
8	146	19	6	low	unsettled-ss	-
9	143	51	2	low	mas-unsettled	mas/swa
10	149	9	2	low	quiet-unsettled	mas end/swa
11	150	29	3	high	unsettled-mis	mis/maf/swa
12	161	20	5	high	unsettled-active	maf/spe/swa
13	142	23	2	low	unsettled-active	spe end/swa
14	136	16	4	low	quiet-active	swa
15	131	39	4	moderate	unsettled-mas	mis/swa
16	122	23	3	low	quiet-active	swa
17	124	17	4	low	quiet-active	swa
18	127	14	1	low	quiet-active	swa
19	135	9	4	moderate	quiet-unsettled	swa
20	128	14	3	moderate	quiet-active	swa
21	131	19	2	low	quiet-active	swa
22	128	19	2	moderate	unsettled	swa
23	121	9	5	low	quiet-active	swa
24	115	27	4	low	unsettled-mis	swa
25	117	14	3	low	quiet-active	swa

### Official NRC Stationery

Professionally-printed with a new design ... just what you need for those verie requests, or for any correspondence. Sold in 100-sheet packs for \$5.00. Order from NRC Publications - Box 164 - Mannsville, NY 13661. NY orders, please add sales tax.

### TOWER TIP

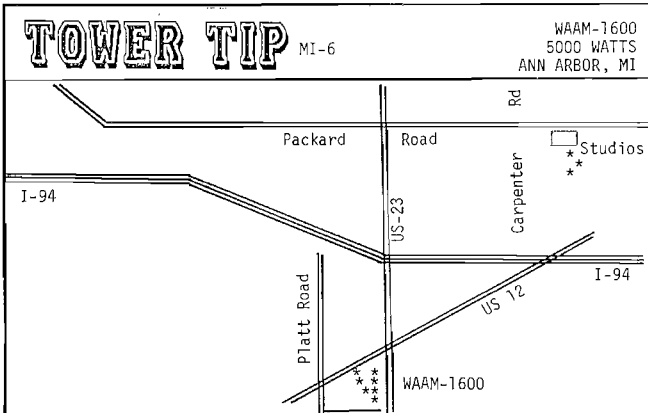

WHAT TO LOOK FOR: Seven equi-height towers in a "V" pattern; there is a "WAAM" sign visible from route US-23. It is not clear what the three towers are for at the studio site up on Packard Road.

CONTRIBUTED BY: Harold Frodge, Midland, MI



The highlights of the 1992 NRC Convention at Omaha are available on four C-90 cassette tapes in a convenient carrying/storage case for \$9.50. Order your set now from NRC Publications. New York residents, please add sales tax.



From NRC's DX Audio Service ...

### 'After Dark 3'

Four C-90 tapes in a holder now available for only \$9.50 postpaid. Listen to interviews with Jonathan Marks, Bruce Elving, and with Fred Vobbe answering your questions ... and features including profiles of WOJD-FM, the Kids format, and Pete Kemp's "Radio Roundup" ... and more! "After Dark #2" is also still available at the same price. Order from NRC Publications - Box 164 - Mannsville, NY 13661. NY orders, please add sales tax.



26	117	8	2	low	quiet-unsettled	swa
27	122	9	2	low	quiet-unsettled	swa
28	126	11	3	low	quiet-unsettled	swa
3/29	129	13	3	moderate	quiet-active	swa

## Geomagnetic Summary March 30 1993 through April 25 1993

Date	FLUX	A	K	SA	GEO	ETC
3/30	129	17	2	low	unsettled	swa
3/31	125	7	3	low	quiet	swa
4/ 1	124	8	2	very low	quiet	-
2	121	5	2	very low	quiet	-
3	117	1	1	low	quiet	-
4	116	26	6	very low	mis-mas	mis 1434
5	119	66	2	low	active-mas	mas
6	-	-	-	-	-	-
7	130	13	1	low	quiet-unsettled	-
8	143	17	2	low	unsettled-active	-
9	136	20	5	low	active	-
10	-	20	2	low	unsettled-active	-
11	119	9	4	low	quiet-unsettled	-
12	103	11	2	low	quiet	-
13	97	25	4	very low	quiet-mis	-
14	92	17	4	very low	quiet-active	-
15	88	26	4	low	unsettled-active	-
16	90	12	2	low	quiet-active	-
17	96	8	4	low	quiet-unsettled	-
18	106	16	3	high	unsettled-active	maf 1950
19	111	9	3	low	quiet-unsettled	-
20	119	23	4	low	unsettled-active	-
21	119	25	4	low	unsettled-active	-
22	117	15	2	moderate	unsettled	-
23	122	9	3	low	quiet-unsettled	-
24	129	7	2	low	quiet	-
4/25	125	13	1	low	quiet-active	-

Flux - Ottawa 10.7 cm (2800 Mhz) radio flux observed at approx 1700 UTC.

A - Fredericksburg VA magnetic field monitor 24 Hour index. An A > 30 indicates local geomagnetic storm conditions

K - Fredericksburg VA magnetic field monitor index. 0 - very quiet, 9 - extremely disturbed. There are 8 of these per day, I only tabulate the 0600 UTC one (I usually monitor WWV/WWVH at 0618/0645).

SA - very low - less than 5 quiet regions on the solar disk, fewer than 10 C-class subflares, no important centimetric radio bursts or sudden ionospheric disturbances. Low - between 5 and 10 quiet regions, only C-class subflares, no important centimetric radio bursts or sudden ionospheric disturbances. Moderate - eruptive regions on the solar disk, fewer than 5 M-class x-ray events, important centimetric radio bursts or sudden ionospheric disturbances. High - active regions on the solar disk, several M-class x-ray events, important centimetric radio bursts and strong ionospheric disturbances and/or one or two importance-2 chromospheric flares or X-class x-ray events. Very High - one or more regions on the solar disk capable of producing proton events, one or more chromospheric flares of importance 2 or greater, outstanding centimetric radio bursts (500 flux units or greater), X-class x-ray events and major sudden ionospheric disturbances.

The above information from the guide to Solar-Geophysical Activity published by NOAA in Boulder CO. I use the information to attempt to discern trends in MW propagation DX conditions in the 27 day solar cycle. Certain DX conditions MAY repeat every 27 days.... phil b

## NRC-525: Filter Leakage ... by Dallas Lankford

In my recent article, "NRD-525: A Technical Review," I said that no filter leakage was present in the NRD-525s I tested. I was wrong. The method of measurement I used was not accurate below about 65 dB down on the filter skirts, and the "leakage" began about 70 dB down on one skirt of the INTER filter, and about 75 dB down on the other skirt of the INTER filter. The "leakage" is not observed for the WIDE filter when the test signal is injected at the antenna input terminal, as I did, because of the bandwidths of the cascaded filters ahead of the WIDE filter.

Before discussing the technical details of the "leakage" problem, let me describe a cure for the "leakage" problem. Replace L4, L5, L6, and L7 on the CFH-36 IF FILTER PC board with ferrite toroid chokes. For L4 and L5 replacements I used 25 turns of #22 enameled copper wire on Amidon FT-50-43 ferrite toroid cores. For L6 and L7 replacements I used 20 turns of #22 enameled copper wire on Amidon FT-50-43 ferrite toroid cores. You can purchase the FT-50-43 cores and #22 enameled copper wire from Amidon, P.O. Box 956, Torrance, CA 90508, telephone (310) 763-5770. Write for their catalog. By using #22 wire the finished toroid coil is sturdy enough to be self-supporting. However, I tied the ends of the windings with nylon cable lacing. At the output end of the INTER filter I mounted the toroid on its side flat against the PC board. I mounted the other toroids upright. A partial schematic of the NRD-525 filter board with changes indicated is given below.

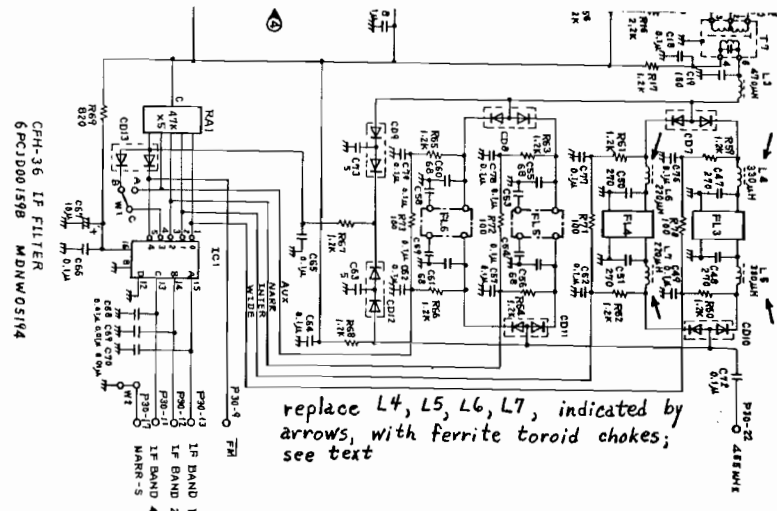

Magne's RDI white paper review of the NRD-525 (Edition 2.0: 11 June 1987) stated that 525 filter leakage was "due to cross coupling in the matching networks of the IF stage," and that it "can, under extreme conditions, allow for penetration of adjacent interference." Magne's review also stated that "Sherwood has drawn up a tentative solution -- a variant of that used earlier on the '515 -- to improve the ultimate rejection on the '525 to -80 dB or greater." Sherwood's catalog (undated, about 1991) stated "improvement of existing AM and SSB filters can be realized with circuit changes to the i-f filter board. A 20 dB improvement in existing ultimate rejection is typical. Circuit modifications: \$39.00."

To understand the 525 filter leakage problem, you must consider all of the filters in the receiver. A block diagram of the 525 and some typical filter parameters are given below in Figure 1.

## NRC Letter Opener

**\$2.25 each;** Sturdy yellow plastic ... opens letters, cuts string, poly bags, package wrapping, and more! Order from NRC Publications - NY orders, please add sales tax.

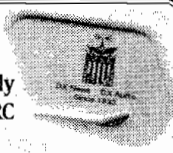

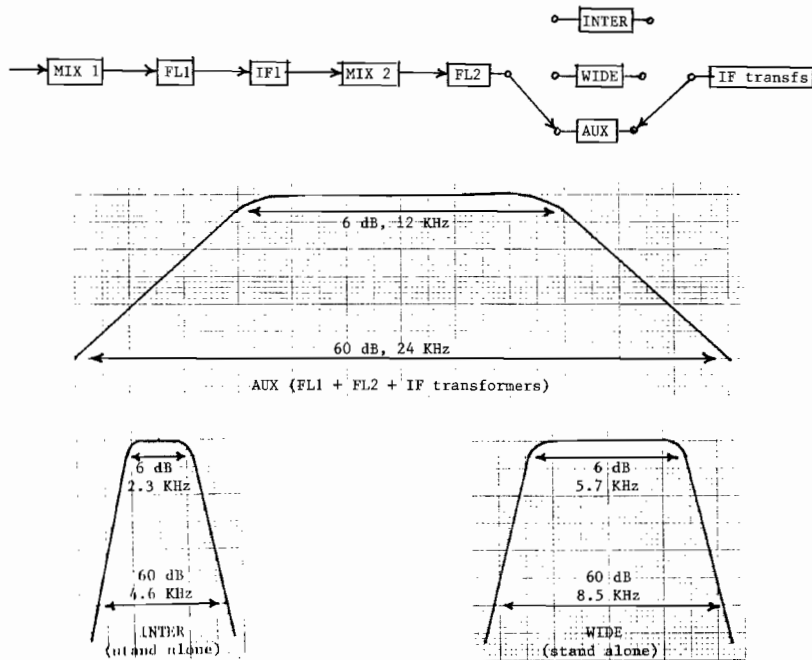

Figure 1

Let us suppose that the ultimate rejection of the WIDE and INTER filters is limited to 65 dB. When either the WIDE or INTER filter is selected, the filter is cascaded with all the other filters in the 525. Attenuation is additive, so the cascaded filter response when measured by injecting a signal at the antenna input and measuring the signal at the audio output should resemble the solid lines in Figure 2 below.

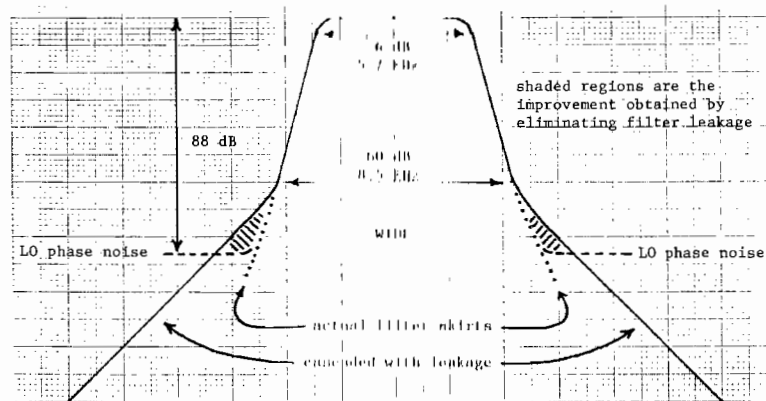
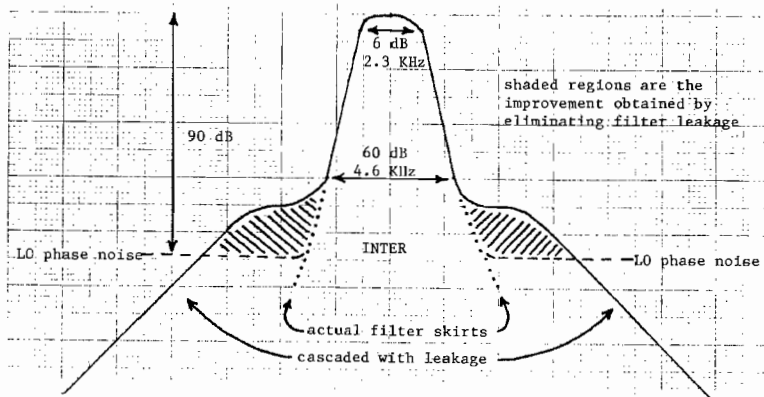

Figure 2

When cascading is included, the ultimate rejection of the WIDE or INTER filter is clearly well in excess of 100 dB. However, the effective ultimate rejection of an NRD-525 within about 50 MHz of a strong signal is determined not by the cascaded filters, but by local oscillator (LO) phase noise for the standard AUX, WIDE, and INTER filters, and for any added filter. In other words, the ultimate rejection of a 525 is LO phase noise limited. For example, at  $\pm 10$  KHz from the LO, phase noise is typically 124 dBc/Hz. This means that at  $\pm 10$  KHz from a signal injected at the antenna input, noise due to the LO will be about 90 dB down when using the INTER filter, and about 88 dB down when using the WIDE filter. Thus, if you measure the filter shapes by injecting a signal at the antenna input, the ultimate rejection of the WIDE and INTER filters would appear to be 88 and 90 dB respectively at  $\pm 10$  KHz. LO phase noise is represented by the dashed lines in Figure 2. LO phase noise begins to fall off slowly beyond  $\pm 10$  KHz and may be somewhat higher than shown in Figure 2 at frequencies closer than  $\pm 10$  KHz. For example, I have made measurements with a 500 Hz Collins torsion mechanical filter at  $\pm 5$  KHz and gotten -118 dBc/Hz phase noise, or a 92 dB filter bandwidth of 10 KHz. I am inclined to believe that the Collins filter attenuation at  $\pm 5$  KHz is in excess of 92 dB, which means that I measured LO phase noise. If that is the case, then the dashed lines should slope upwards as the filter skirts are approached. In any case, the LO phase noise shown in Figure 2 should be regarded as the best one can expect.

There is, of course, nothing that can be done to improve the effective ultimate rejection of a 525 because LO phase noise enters the 525 at the 1st mixer, before any of the filters.

As can be seen from Figure 2, the mod described at the beginning of these notes, replacing L4, L5, L6, and L7 by toroid chokes, merely eliminates pieces of the hump on the INTER filter skirt below 60 dB, and takes small slices out of the WIDE filter skirt below 60 dB. In fact, it is difficult to measure any difference between "before" and "after" for the WIDE bandwidth. However, you may as well replace L4 and L5 while you have the filter PCB board out of your 525 in case you ever decide to replace the WIDE filter with a narrower filter.

I missed the filter leakage previously because I measured the filter skirts with the NRD-525 AGC turned ON, and the signal levels I used were so high that the 1st IF amp and 2nd mixer were driven into gain compression when the signal source was tuned below about 65 dB down on the filter skirt within about  $\pm 10$  KHz of the signal source. Beyond  $\pm 10$  KHz FL1 apparently has enough attenuation to eliminate the gain compression, and measurements with the AGC on are again accurate. The correct way to measure the deep (below 65 dB) filter skirts within about  $\pm 10$  KHz of a signal source is to measure upward from the 525 noise floor with the AGC turned off.

Is the NRD-525 filter leakage substantial enough to allow for penetration of adjacent interference under extreme conditions as suggested by Magne? I doubt it. I did very careful before-after listening under the most extreme conditions I could find, and I could not hear any obvious difference. But then I did not have two 525s, one modified and one unmodified, for simultaneous comparison. So perhaps there are a few DX situations per month where the mod provides slight improvement.

## The Challenging Crystal Set

For hobbyists demanding the ultimate DX challenge, Ray Cole's publication detailing step-by-step procedures in building a crystal set is for you! Only \$3.50 ... order from NRC Publications. (NY residents, add sales tax)

Figure 3 below shows the before-after shape of the INTER filter in my NRD-525. As can be seen, the results are not as dramatic as suggested by Figure 2. The main reason for this difference is that the INTER filter in my 525 did not have as much leakage as suggested by Sherwood. The in-circuit ultimate rejection of my INTER filter was about 75 dB, compared to 65 dB reported by Sherwood. Apparently there may be considerably variation in the amount of leakage from one 525 to another. You can also see that the LO phase noise is not as flat as indicated by Figure 2, and that the LO phase noise for my 525 is not symmetric. The measurements for Figure 3 were made centered at 1880 KHz. I have noticed that at other frequencies the upper and lower LO phase noise sidebands are more symmetric.

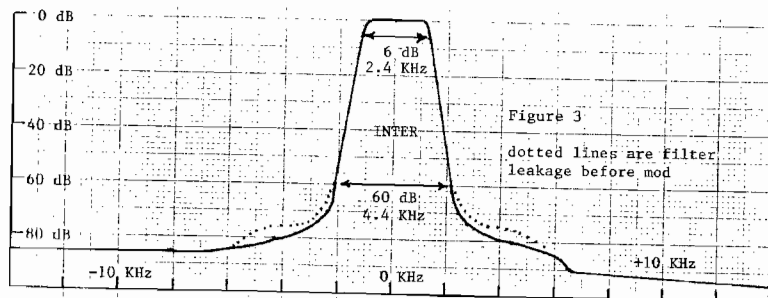

One thing is clear as a result of these measurements and observations. Filter cascading by installing add-on filter boards to improve the ultimate rejection of the original 525 filters is unnecessary because the ultimate rejection of the existing 525 filters exceeds LO phase noise when filter leakage is eliminated. Since the amount of phase noise passed by a filter decreases as bandwidth decreases, it is worthwhile to eliminate filter leakage for narrower filters. For example, with a 500 Hz bandwidth Collins CW torsion mechanical filter, the measured noise was 92 dB down at  $\pm 5$  KHz. As I said before, it is impossible to determine whether this noise is LO phase noise, ultimate filter attenuation, or signal leakage past the diode switching circuit. But it does establish some upper bounds for each: my 525 LO phase noise at  $\pm 5$  KHz is less than -118 dBc/Hz, my CW filter has at least 92 dB ultimate rejection, and the diode switching circuit in my 525 has no more than -92 dB leakage. Some writers have suggested that the 525 diode switching circuit is not capable of such high isolation, but clearly it is.

I would like to express my appreciation to Craig Siegenthaler and Denzil Wright for pointing out that my previous AGC ON method of measurement was not correct in some cases, and to Denzil Wright for many long discussions about LO phase noise and filter leakage.

### IRCA AM-FM ALMANAC - Limited Edition

The 5th Edition of the IRCA AM-FM ALMANAC has sold out, and the 6th Edition will not be published until next year. But several NRC members have expressed interest in obtaining the most recent Almanac edition from 1991. To satisfy this demand, a **limited number** of copies of the 5th Edition will be published this summer. IRCA would like to know how many copies to print.

■ **1991 Edition** — This will be the edition sent to the press in October 1990, and as such all sections are at least that old, with some information from 1988 and 1989.

■ **Looseleaf Edition** — This edition will not have a comb binding. This will allow IRCA to copy the necessary pages, to send you a complete book ready to hole-punch and place in a binder.

If you already own the 5th Edition, this will be no different. If you do not yet own an IRCA Almanac and you want up-to-date information, you may prefer to wait for the new 6th Edition next year.

But if you want the 5th Edition, please let IRCA know as soon as possible. NRC members are eligible for the IRCA member price of \$13 U.S., \$14 Canada. **Send no money at this time.** Write to Bill Hardy, 2301 Pacific Ave., Aberdeen, WA 98520-4527. Thank you!

### A DXers TECHNICAL GUIDE

Now in its 2nd edition, this 120 page book answers questions on receiver and antenna theory (how to improve their performance), how audio filters and loop antennas can improve DX (and hints on their construction), how to build a beverage and phasing unit, and much more. Only \$5.50 for NRC/IRCA members, \$6.50 for non-members (overseas airmail add \$2.50). Order your copy today from: IRCA Bookstore, 9705 Mary Ave NW, Seattle WA 98117

## Musings of the Members

Dave Schmidt

P. O. Box 11502

Wilmington, DE 19850-1502

Times are local per Muse; submit double-spaced only.

Thoughts from NRC members ... the opinions expressed in this column are those of the individual writer and do not necessarily reflect those of the editors, publishers, or the National Radio Club, Inc.

DON TRELFOED - PO BOX 120 - ST. ANNS BAY, JAMAICA, WI  
-----  
Now that we are very well settled in down here in sunny Jamaica, I think it is time to MUSE. First, an update on my DX progress for 92/93's season, verifications to date 339, making an all time total of 1057, adding 3 new countries (Antigua, Cayman Islands and Mexico), for a total of 9 countries, adding 1 province (NS) and 4 states (AR, AL, MS & PR (a state?)), most veries from ON-51, NY-49, PA-45, OH-25, FL 16 (from 2), MI-11, MA-10 and the rest are single digits for a total of 36 states. Some graveyard achievements, also. I don't know if there is any DX season down here (continuous summer!), but I do notice it is harder lately for get any distance. Intend to continue all spring/summer anyway. Have a LW running from my MFJ indoor active antenna, goes to the top of the roof and across an upstairs patio to a large breadfruit tree, approx. N/S, E/W. I intend to string it from a tall willow tree on one side of the house to the breadfruit tree but have to locate more wire (most place here don't know what an antenna is!) and will have to hire a young person to climb the trees. Pet peeve is the Cubnas (one/two on each frequency and their central and eastern coast is about 100 miles N), most are off by midnight anyway. Can pick up almost all of the Jamaican AM here but have not sent any reports yet. A number of new stations have sprung up here but all are FM, guess good old AM is not in fashion here. Would be happy to hear from any member. No phone yet. 73s

ELLIOT R. STRAUS - 980 COOPER ROAD - TOMS RIVER, NJ 08753

-----  
Hi gang! Well it is almost May and conditions still remain fairly good. Sunset continues to be productive for me although MM's haven't been to great. In 10 weeks since my return to DXing, I've logged 136 new stations and have sent out 130+ reports with 61 veries back so far. On 4/6, I heard Arabic under WBZ and thought I had something really exotic until they signed off as WNTL. Well, not exotic...but needed anyway! WLCY-1550 seems to be running full power all night now (listed as 7 watts night), they've been dominating 1550 here on MM's. Recent veries in from WHAT, WRCP, WTZE, WKOX, WTRP, WSR0, WPPQ, WSGH, WBIS, WMDH, WZYX, CIAO & WSKE. WMDH is my 20th verie for a 250 watt station. I have 28 veries from stations with 500 watts power. I hope everyone is making plans to be in Enfield in Sept., it should be a good one. Truly amazing is the fact that the 70' LW antenna I put up in January has survived all the storms and heavy winds. I wouldn't have bet a nickle that it would stay up through all of that, it swayed and rocked and rolled but hung in there. Pet peeves for this month: baseball games in the early evening, and Jim Bohannon on MM's. With the season winding down, that's about all I have for now. I'll probablt start sending out a lot of follow ups in the next 6 weeks or so and try to DX MM's as long as its worthwhile. Best 73s to all and good DX!

MIKE SANBURN - P O BOX 1256 - BELLFLOWER, CA 90707

-----  
Greetings! My ears are still ringing from the Paul McCartney concert. I'd like to say hello and welcome to old friend and new member STEPHEN JARVIS, that makes 2 new members in the Long Beach area in a little over 1 month. S CA is still the DX capital of the world in my humble geocentric opinion. Of course, living here puts a damper on the prospect of logging all 50 states but I do OK. The KKAR DX TEST was logged here on 3/15. Quite a few tests made it this past season including KDES, KCKY, KAAM, KNAK, KNEB, KNZZ, & KAZM. Hopefully next season I'll catch something with a 'W' in it. Got a good reception report off to KVON the other night, usually 1440 is dominated by KDIP/KMED/KUHL (or KOPA in the mornin). Got a letter from KTMG-1370 saying they were back on the air with a country format and new owners. There's something to try for while KEEN is silent. I heard the name of a fellow DXer FRANK MERRILL mentioned on a recent Dr. Demen-tion show, seems he sent in a record rarity called "My Ken L. Ration". I want to say thnaks to DANNY ROBERTS for the aircheck you sent, it's the next best thing to being there. One place I will be is the IRCA Convention in Billings, MT this June. Hope to do lots of remote DXing. Would love to go to the NRCs 60th also, it could happen with enough determination and frequent flyer points. Interesting news re the Superadio III in V60#24P26, unfortunately mine is one of those '92 models, so for now I'm sticking with the II until I can find a Sony 2010 or something comparable. Good DX - 73

ROBERT RUSH - 50 PEQUOT ROAD - SOUTHAMPTON, MA 01073-9587

-----  
I hope everyone had a satisfactory winter AM DX season. My work responsibilities keep me busy, however, I've been able to make a few loggings using my new Drake R8 and Quantum Loop. I recommend the Quantum Loop produced by GERRY THOMAS, it's a great loop antenna! Anyway, here is a list of new stations heard at the shack: WTAM-870, CFFX-960, WSKW-1160, WMZQ-1390 & CBE-1550. Having been out of the AM DX hobby for a few years, I find myself being challenged on frequencies that were once clear like 1160 & 1200. In a world that is constantly changing, it's nice to see a hobby that is bringing new members and 'old' members

back into the fold. I'm glad to be back with the NRC. Hope everyone is able to log a few new stations this spring. I look forward to meeting many of you in Enfield, CT! 73

RON MUSCO - BOX 118 - POQUONOCK, CT 06064

- - - - - An observation, are there any Castles' in New Castle, DE? (No, but the WSRD bumper sticker is still there!-DWS) I received a phasing unit from MARK CONNELLY and the initial results are encouraging. Manchester on 1230 is about 10 miles away, and at 6:30PM the other weekend, I was able to phase the Spanish speaker into oblivion and hear WERI Westerly, RI & N Adams, MA. Normally, I would need a loop and very good conditions to hear these 2 after sunset. But they were heard in broad daylight! SCHMIDT says the standards station I'm hearing on 1360 with WDRS phased is Binghamton, NY, once again in broad daylight. As ZAL MERRIMAN says, its not the answer but a nice addition. (Dynamite really works the best-hi!-DWS) Otherness: no veries from the WKTX-830 or WWJZ-640 TESTS (why am I not surprised on WWJZ?). Convention plans have started as time is slipping by. Be sure to attend the convention and see who wins "The BOZO" award, members whose last name begins with the letter 'S' are eligible (ie: Schmidt, Smith, et al).

CESAR OBJIO - CALLE ENRIQUE HENRIQUEZ 69 - SANTO DOMINGO, DR

- - - - - Hi friends! I am very thankful for the 2 letters received from JIM RNRNRRW, one with the stations heard on FM and the other with what was heard on AM during his stay in Puerto Plata. I enjoyed it but he did not call. For any DXer coming to Puerto Plata, or to any town in the DR, if you do not have my phone number, it is listed in the telephone book, listed by towns in the whole country. You must dial '1' plus the number, that is all, I am usually at home at night watching cable TV or listening to AM. On Good Friday, I was watching "Jeopardy" and one of the questions asked was an audio, of which I knew the answer as "The Synchronized Clock". Can someone make a copy of it for me who may have this record? In return, I would be willing to cover expenses or trade it for a tape with merengues, boleros, popular Latin music or the like recorded from our local stations. anybody willing, please let me know. As usual, most of our stations closed down for Good Friday & Holy Saturday with the exception of the religious ones on 1440, 1480, 1510, 1540, 1570 & 1600 (yes, the high side of the dial belongs to religious stations). I heard something but almost nothing new, this DX has gone to IDXD. Not much DXing as I had to work around the house. Anyway, I liked the rest and change while most people in the city go to their places or origin in the country or to the beaches. Streets are almost deserted and everything is quiet. Catholic churches in the colonial section of the old city have a special program with many attending their activities. On Good Friday afternoon, they present the 7 Words Sermon at one of the churches, said by 7 different priests, on the radio. Also, a note, Radio Guarachita-690 plays Beethoven's nine symphonies on Good Friday afternoon starting at 12 noon till about 7 in the evening, they do that every year. So long, Friends, see you soon!

JOHN SAMPSON - 4949 ALDRICH AVE S - MINNEAPOLIS, MN 55409

- - - - - Greetings! Have been meaning to get this off since the Omaha convention but travel, holidays and otherness have postponed it. First, a big, belated thanks to ERNIE WESLowski and the "Big O" team for putting on a great convention, the first one I've been able to attend since the 1976 CT convention and I really enjoyed it. In late Oct., we again visited Australia and were also able to include New Zealand in our itinerary. In Australia, we visited Perth and a portion of WA, Kangaroo Island (off the SA coast), the SE Tasmania (from Launceston to Hobart) and also spent 2 nights and a day and a half crossing the Nullarbor on the train from Perth to Adelaide. NZ sites included Christchurch, Queenstown, Wellington, Rotorua and Auckland (and many intermediate others). Took the TRF along and was able to hear many fascinating stations (would like to try the 388 from places like Bussleton, Kingscote and Orford, shore locals who try the 388 stations). While in Perth, we visited the Commonwealth Book Shop and I bought 3 interesting books ('Broadcasting in Australia', 'Radio & TV stations -1992 to Present', & 'Commercial Radio & TV service Area Maps'). Thanks to a tip from JEFF TOMASIN, I had written the Australian Dept. of Communications and was advised that at these books were available at the Commonwealth Book Shops in each of the Australian State's capital cities (the books can also be sent to the US but the postage is quite expensive). We arrived home in late Nov., in time to do the holiday necessities and then drive to the Boston area to spend Christmas with our daughter and son-in-law who live in Belmont. (Question for someone in that area, who do the 4 very large towers in W Belmont belong to?) Also had a great visit with ERNIE W. & SKIP D at Skip's place in late Dec., it was fun to see Skip's old convention pix!

TOM BRYANT - 849 TODD PRIES DRIVE - NASHVILLE, TN 37221

- - - - - Wow! When the guys at GE named it the "Superadio", they weren't kidding! I managed to pick up a factory reconditioned Superadio II a couple of months ago and was flabbergasted. Talk about "bang for your buck". My advice is to try and find one before they are all gone. Another addition here is a Yamaha TX-930. I bought they primarily to get back into FM DXing but it also has a hot AM section. Borrowed a loop from local NRCer DOUG SMITH and have been much impress-

ed. The problem is now that I have to give the loop back! I am now looking for input on what to buy, help would be appreciated. I do have a lot of line noise, so keep that in mind when you comment. One other requirement is that it has to look fairly decent, I don't want something that looks like a Dutch windmill or a scarecrow frame! (Yeah, one will blow the others away, the other with scare them away-hi!-DWS) With right at 100 new loopings since Nov., it's been a pretty good season here. New total is 531. Special thanks to the guys arranging the CPC test, they have not only been fun but very productive. Early morning of 3/11 was interesting, E & N was dead and there was a tremendous opening to the W. KSL was totally obliterating local WAMB & Wild. HHR was way over WPTF, KNX was dominating 1070 (usually a mess here) and KTWO was taking an opening as WBZ! Thanks to all NRC members who commented on the 'Monitoring 'Hoop' bit on my career, nice to hear from everyone. At the risk of rattling traditions, I'd like to pass along an idea I've been thinking about for a long time. As a DXer with several areas of interest, I'd like to see consideration given to some sort of 'super club' that would encompass ALL forms of DXing, beacons, HRS, SW, phasers, cellular phones, you name it! We may be light years away from anything like that but maybe it's a goal that ANARC could work toward. I can see a lot of benefits, such as a large enough membership to base that we could afford to put out a good publication and perhaps afford to pay an editor. This may be a way to eliminate a lot of duplication on information. How's that for opening a can of worms, just an idea but I wonder if anyone else has entertained similar thoughts. In general, I'm in favor of whatever is best for the hobby as a whole and since DXing is multi-faceted, it might be interesting to pool all of our various observations. (I believe this was the case with the Newark News Radio Club and HARRA (they just NASA) years back but many just have an interest in just one specific area thus the many specialized clubs. To make a publication that would have to go into great detail on various items in the radio spectrum would really be a HOOR \$\$\$ figure!-DWS) A final note, had a nice visit with ERNIE WESLowski who stopped by WSM on his way through town. If any of you are planning a trip down this way, let me know and maybe we can get a cup of coffee or something. Good DXing and plan to be in Nashville July 23-25 for the 1993 WFTDA convention. DOUG SMITH and I are co hosting and want to assure you that although its mainly a TV-FM club, there are a lot of AM guys in our midst and NRCers will be very welcomed! (Hey Tom - you've got a PDS....a "Please Double Space" request....or you'll get it's admitted on tape of the WVCH infamous Test Tone!-DWS)

DAVE BRAUN - 11 MILL BEND ACRES - WYOMING, DE 19934-9523

- - - - - The Blizzard of '93 has come and gone here, and although we were without power for about 8 hours on Sat. the 14th, we weren't hit with as much snow as a lot of areas got. I did a little bit of listening during the day but didn't notice much that was out of the ordinary, although some stations seemed louder than usual. DX since the beginning of the new year has included a couple of strong openings in daylight hours to very specific areas. On New Years morning from 0830 to 0930, had a great opening to W NY including WHHO-1320, WTLB-1310, WHLD-1270, WPKY-1280, WLEA-1480, WWWG-1460 & WBYB-1400-VT. On the morning of 1/27, had a great opening to New England from 0800 till 0845 which included WLNH-1350, WCFR-1480, WYKR-1100 (no sign of WHLI), WPRR-1470, WKXZ-1020 and tentatives on WDER-1320 & WSBS-860. Traveled to VA Beach in early March and noted WVAB-1550 back on the air with Business News/talk. Some DX: 1/15 12:17AM, finally got an ID on WKTP-1590, 1st time since their call change a while back. While looking for WBNS-1460, at 12:30AM, I heard an ID for WYMA with a promo for a sports call in show on Sat. A. On 3/20 after a couple of days of louder than normal signals from the York/Lancaster area, finally got an ID on WJAN-1390 under wmqz at 8AM. 3/27 around 10:25PM, an UNID sports call in program was noted on 900 sometimes even with CHML. This is the 2nd time this year I've heard this one, does anyone know who this might be? Not much luck in the recent DX TESTS either. Anyone interested can contact me on Prodigy at DPPP10A or CompuServe at 73520,657.

JOHN TUDENHAM (WØJRP) - 2824 MISSOURI JOHNSON, MO 64804-2755

- - - - - More additions to or corrections to the St. Louis radio scene in years past. I grew up in the St. Louis area and started DXing at the age of 8 in 1938 when my dad bought me a Philmore crystal set. I do remember KSD & KFUP sharing time on 550. WEW was on 760, later going to 770. KMOX was on 1090 going to 1120. WIL was on 1200, later to 1230 then to 1430 with 5000 watts in 1948. KWK (now KASF) was on 1390 going to 1380. WFMV 1500 going to 1490. KKOK went on the air about 1939 on 1250 going to 1330 with 5000 watts a few years later. Around 1941, there was a major frequency shift of all US stations above 750 khz with all stations going from 10 to 90 khz, mostly up. WIL was located on the MELBOURNE HOTEL in mid-town St. Louis (studio & transmitter) with 250 watts. When they moved to 1430 in 1948, the transmitter moved across the river to IL with a directional antenna system. Around 1945, WIL-1230 was my favorite station with the pop music of the day (big bands and ballads) and St. Louis baseball with Harry Carey (his 1st year) and Gabby Street. They were also the 1st station to go 24 hours on the weekends with a program called "Dawn Patrol" with Ed Rutledge, a big hit with the teenagers then. Also remember WIL-FM going on the air in 1947, later going off the air with most other FM stations!

ROY H. MILLAR - 13714 30th AVE NW - MARYSVILLE, WA 98271-7007

----- A little bit about a few hours of listening on the AM band from a location near Keauhou Bay, Island of HI (about 5 miles S of Kailua-Kona) at the end of Feb., using a Sony SW1 with a Radio West unamplified ferrite bar. Mid-day band scans netted all NRC log (1992) listed in the state except KHLO-850 & KAHU-1060 could not be heard until toward evening, probably because I was in the shadow of Mauna Kea/Mauna Loa 13,700 feet or so! KUAU-1570 not heard, presumably not on the air. Technically, I didn't hear KIPA-620 in Hilo as the strong Kona coast signal was undoubtedly from the Kalaea SX. KPUA-670 did make it in (10 or 50 kw, I don't know). I wasn't aware of the KIPO/KIPO-1380 call change so can't say for sure which was in use, but it seems to me like "Ripo" was the slogan used. 1992 WRTV CPs, KXDS-810 & KJRI-970 not heard, don't know if they are active CPs or not. KWA712-1610 not heard at Kona, forgot to check out at Volcanoes NP but saw no sign re same. Limited evening listening (to about 10PM local time) netted the following: Most distant IDed: Tonga-1017. Lowest powered IDed: KMNy-1600. Furthest N IDed: KIRO-710. Again, perhaps location to the W of Mauna Kea/Mauna Loa did not favor American reception. Thank goodness I took the ferrite bar antenna along, signals were just not there on the SW1 without antenna assistance in most instances. Appreciated the 9Khz option on teh SW1, sure facilitated scanning for TP splits. Twice, "Radio Australia" news tipped me off to stop and listen, I had no log with me but a good idea of what might be heard from the south. 73

ELLIOT R. STRAUS - 980 COOPER DRIVE - TOMS RIVER, NJ 08753

----- Hi gang! DX continues to be very good here with 45 reports out so far in March. Recent varies are in from WWII (great call letters), WWK6, CHTN, CKTY, WARD, WBUD, KBOA, WLNL, WADV, WIMX, WUOK, WLEE, WQRX, WVNE, WIF1 & WPUB. All my loggings and DX of interest has been reported to the appropriate columns. MM's have been pretty poor with lousy band conditions but 3/22 was pretty good. I got a good log on WMDH-1550. 1550 is definitely my all time favorite freq. with 42 stations logged from 21 different states and 3 countries including 250 watt stations from IN, Cuba, FL & NY. My next best freq. would be 1580 with 39 loggings, 26 watts each on 1550 & 1580. I'm really looking forward to the convention in Enfield and have been saving my bucks to purchase a new Drake R8 and the new K1WA loop for next season. I love the R390A and it will always be my favorite receiver but I'd love to have digital readout and memory. All 390A users will appreciate the difficulty in jumping from 990 to 1000 khz. (There is an easy way to cure that, Elliot, got another 390A!-DWS) I'd also like to be able to program all my dominant stations in memory and on a MM, just run through them to see who may be off the air. Well, that's about it from here, I hope the season last a while longer. Best 73s to all.

ANDY RUGG (VEZEM/1) 175 IVAN CIRCLE - CORNWALL, ON K6H 7C7

----- A combination of events kept me away from the AM dial for most of last year. This winter, my HCB DX was limited to TESTS from WWJZ-640, WVCH-740 & WMUS-1090. New varies are WVCH 740, WKVA-920, WMUS-1090 & WVEI-1440. I enjoyed renewing so many NRC acquaintances at the Kulpville event in Feb. Now that my work schedule is calming down, I may be able to get in some more BCB DX before the season ends. A Quantum loop was added to my shack but I haven't tried it out yet. I also obtained a backup Superadio III. It proved its performance with mid-day reception of WBZ-1030. I expect to attend the Enfield convention. After 33 years of on/off BCB DXing, my totals are now 1759 logged and 1674 verified for a 95.2% return. 73

ROCKY STONE - HCR-1, BOX 407 - HOLLISTER, MO 65672

----- Howdy once again from the Boomin' Branson area. Hope this finds everyone well and happy. Well, DX season seems to be at an end here in the Ozark Mountains as storm after storm obliterates the airwaves. But a good season it was and a special thanks to the CPC dudes for the great tests. I managed to snag 5 varies in record time (the offers for free tickets to our show may have helped!). KWTO-550 is using a lot of audio processing for a news talk station, baseball games sound like the entire bleacher is in the broadcast booth so you may want to keep your ears peeled for that. WCRV-640 is a daytime regular on the car radio, quite a haul from the Memphis area to here. KTWO-1030 blasts in for around 2 hours at sunset, then the battle begins with about 5 others. KIDS-1340 is still going strong with its "strictly for kids" format, their schedule is 8:30A-8:30P but they are generally gone by 4 PM. I still manage to hear about 5 ex-hometown Houston stations up here. For some reason, KGBC-1540 is always stronger on Friday night with baseball games, special dispensation? (No, likely so they can hear the station at the game at night...you'd be surprised how many stations show up at night during high school football in the fall that you never hear otherwise, somehow the night power gets lost that night!-hi!-DWS). An old friend who used to sing at Gilley's Nite Club in TX is now a DJ at WWVI-1000 so if anyone needs a ver-ie, just get in touch with me. Wishing all a no static, allergy free Spring, TTTTTTT (7-T's)!

STEVE BIRO - 1010 PONSI STREET, 1st FLOOR - FORT LEE, NJ 07024-2522

----- Not much excitement on the DX front in the NY metro area lately but there are some interesting tidbits to pass along. No doubt everyone heard of the

World Trade Center bombing on 2/26. The blast knocked off all but one of the NYC TV stations as well as 5 FM's. Only WNBC remained on the air using backup facilities on the Empire State Building. All the other TV's stayed off for up to 11 hours of more being relayed by suburban HDL stations. Programming from the NYC TV stations continued to be seen by people with cable TV within the city itself because the cable companies receive local signals via fiber optic lines, not off air. On FM, WOOD-101.9, WNYC-103.5 & WLIB-97.1 managed to operate via lower powered backup facilities. WNYC-93.9 & WLIB-99.1 remained off until the power was restored to the Trade Center. Despite the problems, local TV & radio did a great job covering the event. Of course, NYC's AM stations were unaffected, so the all news outlets (WINS-880 & WINS-1010) were heard far & wide with their usual coverage. WNBC 1140 seemed to have a hard time keeping up but did a decent job considering their smaller local news staff. That's about it, 73's and great DX to all! (Steve, I cut out the Superadio III info as it has already been printed-DWS)

KEN MACHARDI - CASTILLA 17-17-691 - QUITO, ECUADOR

----- Greetings from Quito! HW B to be interesting from here with stations regularly heard from Columbia, Panama, Costa Rica, Peru and occasionally Venezuela and Bolivia. Also the VOA Belize transmitted puts in a nightly signal as does the Caribbean Beacon. Occasionally I hear Jamaica as well. Radio Cayman Islands will be dropping MW broadcasts later this year. I heard them nightly while we were living in Costa Rica. They sent out a nice confirmation letter so get them while you can. I was sorry to read that the station profiles featured in the past are not too popular. It has been a while since I have seen them in the bulletin and I recently sent off for the separate listing to complete my set before they are gone. To bad someone can't take on that job. I do appreciate the many historical features by THOMAS WHITE. His recent article about some of the really early radio stations prompted me to send in to club headquarters some material which I received from WWJ about a year ago to back up their claim to be the 1st regularly scheduled broadcast station. I have recently joined the NA Radio Archives (c/o: Janis DeMoss, 5291 Lexington Pike, Lexington, KY 40515). They have a fantastic collection of old time radio drama, comedy, etc. I have around 250 to 300 programs on tape now. It has been a real sidelight to the hobby. Thanks to the NRC staff for your good work. BTW, a reminder: we are carrying the NRC Medium Wave Report on HCJB's Party Line every 3rd Saturday of the month (15155, 9745, 21455, 17490 at 8:30, 10:00 & 11:00AM Sunday EDT on 11925 & 21455). We also carry announcements of the CPC TESTS when available. Be sure to tune in!

GERRY THOMAS - 3635 CHASTAIN DR. - FLEMINGHAM, FL 32504

----- Hi again. And get back from the Orlando Hamvention, picked up an Allied SX190 (which I've been looking for for years) for SW work, nothing else to note. I did join the FL Antenna Workshop group, an association of about 400 Floridians with an interest in old time radio of one sort or another. Most of these folks have an interest in HDLs and I found their ranking of the all time best tube type communication receivers noteworthy: #1 Collins R390A, #2 Hammerlund SP-600 Super Pro, #3 Collins 6001, #4 National HR060, #5 Hammerlund HQ180 series, #6 National NC183D, #7 Hallicrafters 2-800, #8 Hallicrafters SX28, #9 Hammerlund HQ145 & #10 Hallicrafters 2-10. Also in the same newsletter was this unreferenced comment regarding the relationship between weather conditions and DX: "Measurements made at various intervals have shown that on a night following a cloudy day, signals were received more readily than on nights following days of bright sunlight. It appeared that a low cloud was most effective when it covered the territory lying between the sending and receiving stations." Make of that what you will. On other matters, I've put together a coupler for use with the Quantum Loop and radios not having antenna terminals. It actually seems to work better on portables like the Superadio than the direct connection method (because you can control the degree of coupling and, therefore, the Q), details in an upcoming article (also some updates on the Quantum Loop). I'll be in OH in late April and will try to get by the Dayton Hamvent, which should be an experience. 73

KARL D. FORTH - 2411 R HELLER PLAINS - CHICAGO, IL 60618

----- I've been spending a little more time at the dials this season than last. Most of the activity this year has been chasing the DX Tests, and I've heard a number that have been needed here. Thanks to those who arranged the Tests! Highlights have been KCNO-570, KNEB-960, WNTK-1020, WNNW-1110 & WWJZ-640, all new here. Other than the DX Tests, activity has been light. The band is a little too crowded to interesting late night sessions and a few times I've tried sunset, the band has been fairly quiet. I have achieved one goal this season, hearing WGN-720 on the air and logging it on that frequency. Wait until next year! One interesting non-DX Test logging has been KFMO-1240, heard once at midnight during the WNBC/WEDC switch. Sometimes there's a gap of a few seconds in which an ID can be heard. I also heard them shortly after midnight another time. My HQ160 is back in action and is being used for both MW & SW DX. Local DXer NORM GEUDER attacked and greatly improved the sensitivity of this 30 year old receiver. I've also been working on a project computerizing my heard log. I've finished all the foreign loggings and all the domestic except for a 4 year gap from 1974 to 1978. Finally, it's good to see DON MOORE in the NRC & reporting! 73



RICK DAU - 917 E. COLLEGE STREET #6 - IOWA CITY, IA 52240-5513  
 - - - - Another DX season is in the books and it was a productive one. I heard over 100 new stations and many surprises and long sought toughies made their way to the shack. Best catches were probably the 2 DX Tests from NH (WNTK verified, I didn't send a report to WNNW), the NON verifying test from NJ and the amazingly good reception of KCNO-570 for its Nov. test, my 1st regional from CA logged anywhere. I was also pleased to snag some hard ones that I'd been chasing for a while, such as WDBC-680, CKAP-580, CFSL-1190 & WROM-710 (still no trace of WJEP, however!). Total heard here as of May 11 stands at 977. Incidentally, my final new catch of 1992 was WDMA-1070. I really want to extend my thanks to both the NRC CPC and to J P STEPHENS for an incredible effort in getting all those tests on the air for us this season. I think other NRCers should do the same. There have been some changes on the airwaves in these parts. Davenport-1170 has dropped its long time call of KSTT in favor of KJOC, remaining all sports. Sad to see that call go. Also, KWPC-860 is no longer CW but is now Adcon and ID's as 'Mix 86'. My eye caught a glaring error in AM Switch many issues back. There was some sort of application regarding a station on 1130 in Prescott, IA. Well, Prescott never has had a station and is probably too small to be the site for one! (It's near Corning, if your looking on a map). I am sure this was suppose to be Prescott, AZ. Wonder how that slipped by those organized folks at the FCC? By the time you read this, ERNIE WESOLOWSKI and I will have returned from a worthwhile weekend in LaCrosse, WI and the Ironwood, MI area. Details on the trip next time. Seven Tea Trees (You been hangin' around with WPT again?-hi!-DWS)

ERNIE WESOLOWSKI - 13312 WESTWOOD LANE - OMAHA, NE 68144-3543  
 For the 1st time in 6 days, the sun has come out! Lots of rain in the Heartland and another station has bit the dust. KHAT-1530 went silent on 4/10. KPMO-1480 should return to the air on 6/1 under the new call of KMAM, we will need KOTL-1290 is for sale and KKAR-1180 is interested in buying them. It will give KKAR a much better coverage area day & night. Just today, the EIB network began on SW on 15420 with Rush Limbaugh. Plan on attending Enfield on Labor Day. I will be arriving Thursday and if anyone is interested in sharing a ride, contact me by letter or phone (402 330-7758). I'm also thinking about visiting PO afterwards. A suggestion for those attending the convention, how about bringing 1 door prize and 1 auction item? This will make it all more fun. My flight with the FCC concerning the tone on 1001.4kHz isn't going anywhere. The tone is still there and no response from the FCC. We need 10 to activate an investigation. If you want it stopped, you must write them. Thanks to JOHN D. BOWKER in this matter. My motto: "He who transplanted still sustains." Its also the Communist motto. See you there!

DAVE SCHMIDT - P. O. BOX 11502 - WILMINGTON, DE 19850  
 Except for a report from HANK HOLBROOK, the file is cleared out. We have been pretty busy with work but now we are finding out that many are falling behind in their payments so I've got to play collection person, too. Such is life. Through the grapevine, the sale of WITH-Baltimore to the Kids Radio Network didn't go through so WITH is back on the block, remaining so far with the standards format. The "Help Radio" format folded on WHLP-1360 3 weeks after its start, the station went dark for a few days and has since returned with a standards format, banking on the pending change at WITH which didn't happen. DX is down to nil here, just an occasional check while doing measurements. Start making your plans now to attend the NRC convention, find out what RON MUSCO is REALLY like! Thanks to all for their support! 73's

## "Latin America by Radio" - by Henrik Klemetz

168 pages of tips and suggestions for the non-Spanish-speaking Latin American DX'er. Includes tips on identifications, catchwords, speech patterns, music, newscasts, advertising styles, brand names, weather and time check formats, and much more. \$17.95, from NRC Publications. NY orders, add sales tax.

## Music Grade audio cassettes

C-90 tapes: retail value \$4.00 each; just \$9.00 per 10, \$22.00 per 25, or \$42.00 per 50. C-12 tapes, perfect for airchecks: 10 for \$7.50. Order from NRC Publications - Box 164 - Mannsville, NY 13661. NY orders, please add sales tax.

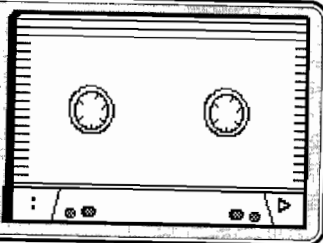

# The 60th Anniversary

The National Radio Club is pleased to announce that its infamous SWAT TEAM has returned from a recent deployment, just in time to host the NRC's 60th Anniversary Convention.

The Convention will be held Labor Day Weekend, September 3rd, 4th, 5th, and 6th at the Harley Hotel of Hartford/Springfield in Enfield, Connecticut.

Contrary to previous statements, the SWAT TEAM is not incarcerated ... yet. And just as in the past, it will endeavor to make this year's Convention a BLAST! Join us for a glorious weekend ... enjoy a "Hillbilly Banquet" on the patio, the NRC Auction, "The Quiz", the "Find the Sticker" contest. John Bowker, Mark Connelly, and Tony Fitzherbert will do their thing and the SWAT TEAM will do theirs.

The Harley is located at 1 Bright Meadow Blvd., Enfield, Connecticut 06082 (I-91 at U. S. Route 5, Exit 49). I-91 runs north-south between the Massachusetts Turnpike (I-90) and the Connecticut Turnpike (I-95).

The Harley has a shuttle bus between Bradley International Airport in Windsor Locks, CT and the hotel. The hotel's phone number is (203) 741-2211.

A form is included for room reservations. The single or double price is the same, \$59 per night, plus 6% state tax. Reservations must be made directly with the hotel. The NRC Convention Committee will not be getting involved with room reservations/room sharing.

A registration fee of Forty Dollars (\$40), which includes the banquet, may be paid in advance. Checks payable to the "National Radio Club" may be sent to NRC Convention - P. O. Box 118 - Poquonock, CT 06064.

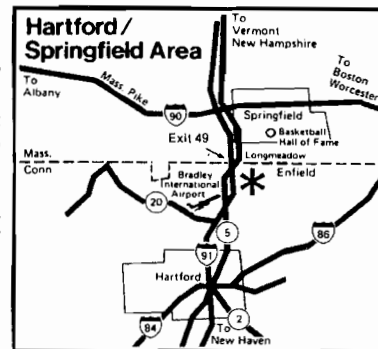

Questions, suggestions, etc., may be sent to Box 118; an SASE is required if an answer is desired. Bring items for the Auction. The 50th Anniversary Convention had about 70 attendees; let's try to better that mark.

\* We will attempt to honor your room request. However, bed types are subject to availability and cannot be guaranteed.

## Harley Hotel OF HARTFORD/SPRINGFIELD

A DIVISION OF HELMSLEY HOTELS  
 1 Bright Meadow Blvd., Enfield, CT 06082  
 CT: (203) 741-2211 MA: 413-737-3206

NAME: \_\_\_\_\_ AMBASSADOR ROOM \_\_\_\_\_ RATE: \_\_\_\_\_  
 SURNAME: \_\_\_\_\_  
 CITY: \_\_\_\_\_ STATE: \_\_\_\_\_ ZIP: \_\_\_\_\_  
 (REQUIRE CREDIT CARD OR AMERICAN EXPRESS OR DISCOVER CARD OR PREPAID)  
 (REQUIRE PREPAID OR DISCOVER CARD OR AMERICAN EXPRESS OR DINERS CLUB)  
 ARRIVAL DATE: \_\_\_\_\_ DEPARTURE DATE: \_\_\_\_\_  
 CHECK IN ADDRESS: \_\_\_\_\_ EXPIRATION DATE: \_\_\_\_\_  
 GROUP RATE: *National Radio Club*  
 CHECK IN: 3:00 P.M. - CHECK OUT: *NOON*  
 Hotel must receive this card by *8/13* to guarantee rate.

The Harley of Hartford/Springfield is pleased you have chosen us for your upcoming visit. We look forward to serving you while you are in our area.

The Harley Hotel regrets that we cannot hold your reservation after 4:00 p.m. on the day of arrival without guaranteeing the reservation with a method listed below.

To guarantee a reservation, we request that you either:

- 1) Enclose a check or money order covering the first night's stay. Deposits will be refunded only if cancellation notification is given up to 24 hours prior to arrival.
- 2) Print below the entire number of your credit card. We accept the following: MASTERCARD, VISA, DISCOVER CARD, AMERICAN EXPRESS or DINERS CLUB. Please include the expiration date.

-THE  
WIZ