



DX NEWS

*the magazine of the
National Radio Club*

← SINCE 1933 →

Volume 48, Number 30 Monday, September 28, 1981

STATIC FROM HQ

The 1981 NRC Convention in Rockaway, NJ is now history, and with this issue Volume 48 draws to a close. A convention report and the first comments of those in attendance are sprinkled throughout this issue, so suffice it to say here that it was one of the most memorable conventions we here in Louisville can recall. And, as always, it is good to be able to finally associate faces to the many names made familiar in the pages of DX News throughout the year. At the banquet we were able to actually say that we could identify every member in attendance from memory!

This issue is a biggie using everything we have been holding the past two months—and we DO mean everything. So contribute NOW to insure the first issue of Volume 49 is just as informative. After several members complained last Fall that the weekly issues began too late in the season, we will go weekly with the next issue dated October 12 and thereafter. A complete publishing schedule is inside on page 21 which we will adhere to barring unforeseen complications.

Russ Edmunds asks that all hams submit update information for the NRC HAM List which will have a deadline of October 20 in NJ. Send info to Russ at Box 127, Boonton, NJ 07005.

A note from former member Bill Damage advises he is now the all night man on CFBK-630 Huntsville, ON which also simulcasts on CFBQ-1340 Parry Sound, ON. His air name is Chris Williams and all reception reports should be sent to his attention for prompt followup.

As mentioned in the last issue, please do NOT send money for advance orders on the new NRC Domestic Log. A firm publishing date and price has not been established yet and we do not wish to field complaints from unhappy customers yet. Plenty of advance notice will be given when we can see the light at the end of the tunnel— hopefully in the not-too-distant future.

CPC TESTS

Two CPC Tests have arrived since last issue—hopefully the first will be heard by many if we can get this issue out a day early.

9/28 Mon. KJNP-1170 North Pole, AK will tentatively run a Proof of Performance w/tones, sweep tones and code ID's 0500-? EDST. Reports to Eric P. Nichols, CE, KJNP Radio, Box 0, North Pole, AK 99705. Arranged by Robert Kramer/NRC.

10/15 Thurs. WVMT-620 Burlington, VT 0015-? EDST opening with ID and repeated every 15 minutes. Will use tones between 50 hz. and 10 khz. If problems occur, test will be rescheduled for next morning, 10/16 at same time. Reports to Michael Seguin, CE, WVMT Radio, P.O. Box 12, Colchester, VT 05446. Arranged by Saul Chernos/GWDXA.

LOOK INSIDE

(Un)Conventional Report.....	2
Domestic DX Digest.....	4
International DX Digest.....	9
DXchange.....	13
Receiver Review-The ICF-S5W.....	14
International DX Achievements.....	15
Radio Wrecked????.....	16
Afr Graphs.....	17
KCAM-Station Profile.....	20
Publishing Schedule-Volume 49.....	21
Some Thoughts on Interference.....	22
Musings of the Members.....	23
Verification Game.....	33
Verie Signers.....	35

AN (UN)CONVENTIONAL REPORT

Having heard that a group of radio freaks and other assorted worshippers of the night were to descend en masse on a hapless motel in Northern New Jersey, this scribe set out to see for himself just what this all meant. I arrived in Rockaway in mid-afternoon on Friday, September 4, 1931 and immediately noted a few individuals with bizarre T-shirts and well-fortified with assorted varieties of beer. I discovered that the majority of arrivals would take place that evening, so I went home for dinner and then returned to find more of these strange people, more shirts, and more beer. They stood about in smallish groups talking, looking at ancient records of their past or playing cards. So far, it seemed harmless enough, as this went on until well after midnight.

Upon returning Saturday afternoon, I discovered that this was indeed a most unusual gathering. These so-called DX'ers now sported name tags with such inscriptions as "Buffalo K. Foonman", "Alphonso Bedoya", "Wizard", "Efram Glotz", and others. Verry Strange!! They then gathered together to speak of their heritage, memories, ancient writings and so on, with the thought toward the preservation of these artifacts. The speakers spoke reverently about their recently-departed bretheren, and invoked their memories often. They discovered that one of their former leaders had maintained a carefully cultivated collection of artifacts called "bulletins", and that he would see to the preservation of this collection. Other announced they would visit other sages of the group not there present, and record their sayings for posterity.

Following this, they again broke into groups, some to play cards, some to talk, some to peruse a collection of artifacts, and others to collectively and in some organized but undiscernable pattern, hold small radios to their ears and compare their listenings. Of all of this activity a record was kept for some obscure purpose. Many then went off to dinner, following which, at some length, they again met as a whole group for a business meeting.

This meeting concerned the perpetuation of their publications and how this might be accomplished. Numbers were exchanged as to the costs of these various enterprises, and no real decisions appeared to be reached. A new proposal was received about something called a "log" and it was determined that this matter would be further explored. Presentations were received for the site of their next such annual gathering, and when the votes were counted, it was determined that Louisville had emerged victorious over something called "Quad Cities". They then proceeded to discuss the fiftieth anniversary of their band, to occur, all things being equal, in 1933. It was determined at some length to accept a bid for this great meeting at Hartford, where grandiose plans were underway for a mammoth commemorative publication of an historical nature. It was generally felt that for this event, greater advance commitment was necessary. Following the meeting, they again split up into varied smaller groups.

On Sunday, a form of auction sale was held, where such arcane items as more T-shirts, and various artifacts from various broadcasting stations, as well as a number of old issues of their own publications and of others were snapped up. Following this, all left briefly and reconvened for a banquet, whereat there was much conversation and picture-taking. Following the meal, several of their sages held forth on their memories of their early experiences in the club's principal activity, namely listening to noise on radios. These ramblings were duly recorded for future playing and transcription. This was apparently the last organized activity, and many prepared to return to their homes, while others stayed to talk, drink, play cards, and listen to their multifarious radios.

All in all, the participants seemed to enjoy themselves rather immensely, and, although much of the goings-on were not comprehensible to outsiders, the end results appear to satisfy their expectations.

- A. Random Stranger

Summary of Business Meeting:

Dick Truax announced that by late Spring of 1932, it would almost certainly be necessary to change publishing committees. Even in the event that it would not be dictated by circumstances, the LPD would desire the change anyway. It was noted that the last transition was eased by timing it after the conclusion of the weekly issues. Russ Edmunds agreed, saying that picking up at the beginning of the volume year as had been done in the prior transition had been easier. A discussion of expenses involved ensued. Russ pointed out that the bulletin costs in Louisville for printing were now actually less than they had been at the close of NJPC operations over 4 years ago, and that an increase would likely be necessary at any new publications site. Dick noted that an increase in costs at Louisville was forthcoming, but had been contemplated in the last dues increase.

Russ also noted the possibility of an outside mailing service to reduce HQ workload, and possibly the number of persons needed. The saving of 4-6 man-hours per bulletin for addressing, stamping foreign bulletins and transmittal would be offset by an additional cost of some \$40 to \$50 per issue. He also discussed several alternative publications schedules considered some years back, which had been rejected as too drastic, among them bi-weekly publication; bi-weekly publication with alternate bi-weekly flash-sheets, all feature and musings published monthly from a separate site; flash-sheets published at a separate site, and alternate week mini-bulletins. Of these alternatives, only straight bi-weekly publication would save on postage, and only that and bi-weekly with flash-sheets would substantially reduce workload, although site-splitting would reduce workload at any one site. None of these alternatives were seriously considered, and no decisions were reached.

On the Log, Dick, Russ and Ron Musco discussed the current situation, and the current editor's intention to step down following the upcoming edition. Chris Hansen volunteered to test out the possibilities of utilizing word-processing equipment to handle the log and its updates, while Craig Healy suggested the use of a college computer science department to possibly take on the project as an educational challenge. Jerry Starr and others will be investigating availability of direct information. It was determined, however, that the log must be automated; and that investigations by Ron and Russ had indicated that either costs or logistics or both would be major problems in the club buying time on a computer, to renting or buying the necessary equipment, as an investment in excess of \$15000 would be necessary.

Two convention bids were received, one by tape from John Clemmer for Quad Cities, Illinois/Iowa and live from Dick Truax and Gary Atkins for Louisville. Louisville emerged the winner. Ron Musco tendered a bid for Hartford for the 50th anniversary convention in 1933, explaining that the plans for publications and other arrangements necessitated a firm commitment farther in advance than one year. After discussing the points pro and con, the convention overwhelmingly decided to break with tradition on this point.

Attendance: Members - 57 Wives and assorted guests - 6

Most distant attendee: Gary Houdek, Munden Ks.

Those allowing their names to be listed as having attended:

NJ: Arey, Paradies, Nitshe, Mount, Fela, Stonier, Edmunds, Harris, Bowker, Lawlor, Barkow, Alisauskas, Bohac, L. White.

NY: Clarius, Lord, Hansen, Weinbrum, Chatterton, Rader, Bond, Foxworth, Bartek, Juen, Brandel

PA: Steward, R. Cooper, Hayes, D. Fox, R. Murphy, Fitzherbert, J. Buehler, Walton

MA: Grant, G. Cooper, Connelly, Farmerie, E. Cooper, Greenburg, Sullivan

OH: Starr, Greene, Krejny CT: Musco

KY: Atkins, Truax KS: Houdek

NE: Wesolowski, McIntyre DE: Schmidt

MO: Eddie DC: Townshend

IL: Gianini RI: Healy

TN: Francis MD: Kadet

ON: Whatmough

Auction: Proceeds: \$422.25
Special HAP Auction netted \$135 for HAP

Totals do not include values of \$800 worth of equipment subject to minimum bid proceeds to owner.

Committees appointed:

- 1) New Log Production Exploratory Committee: C. Hansen, C. Healy, R. Musco, J. Starr.
- 2) Preservation of records, veries, bulletins: J. Starr, R. Edmunds, T. Farmerie, R. Musco, N. Zank, R. Cooper, H. Steward.
- 3) Fiftieth Anniversary Commemorative Program & History :
R. Musco, J. Starr, R. Edmunds, T. Farmerie

Others to be added at their desire and contribution.

(Hansen & Healy each presented alternative potential methods for producing and maintaining the log after the next edition. Further reports will follow)

4 DOMESTIC
DX DIGEST

DAVE SCHMIDT
42 CHELWYNNE RD.
CASTLE HILLS
NEW CASTLE, DE 19720

It was good to be able to meet many at the NRC Convention in NJ over Labor Day. Now many of found out just why this column is like it is-hi! When sending your tips in, please keep them on one side of the paper, skip a line between items, ELT, type or neatly write. Here goes:

SPECIAL:

- 560 WPIL PA PHILADELPHIA - Format: CWM, dropping Top 40, as of 9/4. (TF-PA) May have dropped Enterprise sports, also, will have to check. (DS)
- 980 WPIP FL POMPANO BEACH - Format: Oldies, slogan is "Blue Suede Radio." (SK-FL) Yeech...and yeech-fm. Somebody should tell them how to verify reports! (DS)
- 1240 WBBW OH YOUNGSTOWN - Effective 10/1, they will officially become WBBW! (RK-IL)
- 1300 WFFG FL MARATHON - 8/16 2058 Noted atop channel w/CW music and reports on Tropical Storm Dennis. (SK-FL)
- 1350 WZIX PA YORK - 8/29 0008 s/off noted w/"That's All Folks" so may have dropped AN sked. Still noted w/this call 9/10. (DS-DE)
- 1440 WCHB MI INKSTER - CP for 1000 watts nite is now on, ID's as "More power to the people." Has good signal here with B/SOL format. (JP-ON)
- 1520 WVOI OH TOLEDO - 7/9 0032 noted w/religious tele-talk program, PSA, ID, poor w/WKBW partially nulled, ex-WGOR. (DC-ON) 8/3 0101 fair w/WKBW w/ID then religion. (JP-ON)
- 1540 WRCP PA PHILADELPHIA - 8/30 noted on Rock Oldies show mention that station was off air the week of 8/23 due to a fire in the transmitter. (DS-DE)
- WPXE PA PUNXSUTAWNEY - Officially changed 9/7, as heard on return trip of convention. (JS-OH) You were there? I thought you sent Buffalo K. Poonman as your representative! (DS)
- 1550 WCKG PA BRADDOCK - 7/23 2045 just got ID at end of s/off, nothing more, ex-WFFM. (JP-ON)

FREQ. CHECKS:

2nd THU. . .KMAV-1520 w/TT, ID at end by woman per list. (JP-ON)
WMCT-1390 0015-0030 w/TT, ID's every 20-25 seconds, this one noted by RK a few months back. Not on list! (DS-DE)

Per v/l from WESB-1490, their f/c is still scheduled for the Tuesday AM falling in the week with the 15th of the month, 0000-0030 w/TT. I would suspect it's done during this time period, not the full half-hour. (DS-DE)

MIDDAY - MIDNIGHT:

- 680 CJOB MB WINNIPEG - 7/27 2230 surprised to find this doing so well on severe aurora evening. Noted sports program about Winnipeg Blue Bombers w/CPR nulled. (JP-ON)
- 710 WQKI SC ST. MATTHEWS - 8/29 1801 w/good ID, "Quickie" news/weather, good in WZOO null. (SHP-NC)
- 730 WPAL SC CHARLESTON - 8/29 1730 w/black cosmetics spot, ID, weak u/semi-local WOHs. (SHP-NC)
- 860 CJBC ON TORONTO - 9/7 2250-2300+ looped (not me, the station), 2 men, FF talk, jazz, oldies, "Ici Radio Canada" and mention of Hamilton at 2300 then news. Xint w/WDMG nulled. (NAP-AL) Actually, it was Cuba with a French teaching program....you weren't looped? (DS)
- 930 WLLL VA LYNCHBURG - 8/22 2009 weak w/local Toyota ad, rock.(MT)
- 950 KLIK MO JEFFERSON CITY - 9/7 2325 looped at tune in "right now it's ----- at KLIK," into music, double checked on recorder. (NAP-AL)
- 1000 WIQT NY HORSEHEADS - 8/29 2015 in blockbusters w/Twin Tiers weather, then s/off. (RM-PA)
- 1220 WGNV NY NEWBURGH - 8/25 1925-1930 way atop freq. w/adult contemp. music, traffic report, weather. (RM-PA)
- WPAX VA FALLS RIVER - 8/29 1955-2000 easy behind WCAU (next door) w/news then s/off w/no SSB. (RM-PA)
- 1230 WCLO WI JANESVILLE - 8/23 1900 fair w/ID, AP news. (RK-IL)
- 1300 WKCY VA HARRISONBURG - 8/21 2014 decent w/religion and s/off u/local WFBR. (MT-MD)
- 1330 WYGO KY CORBIN - 8/22 2025 atop mush w/AM-FM ID's, strangely gave scores for Philly teams, ID is sure, though. (RM-PA) ESP....they knew you were listening! (DS)

WBET

- 1330 WADJ PA SOMERSET - 8/18 2015 good at s/off w/man, ended w/jingle ID. (WPT-DC) All of your batteries were in your rx? (DS)
- 1360 WHBG VA HARRISONBURG - 8/21 2015 noted s/off w/Dixie. (MT-MD)
- 1390 KJFW MO WAYNESVILLE - 8/29 1858 fair in WVON null w/s/off w/SSB. (RK-IL)
- KLNT IA CLINTON - 9/4 2014 good in WVON null w/s/off. (RK-IL)
- 1420 WKCV VA WARRENTON - 8/26 1945-1956 CW music, ID's for "Big K" mention of "Big K Little Oprey." (TF-PA)
- WTCR KY ASHLAND - 8/22 2029 in w/brief ID and mention of nearby Gatlettsburg. (MT-MD)
- WEMB TN ERWIN - 8/23 2015 noted a s/off. (MT-MD)
- 1440 WRRO OH WARREN - 7/29 1636 fair o/u WBCM w/ID, logged for call change, ex-WHHH. (JP-ON)
- 1450 WRRL VA LEXINGTON - 8/23 2028 surprisingly nice w/CW music, ID, local/regional news. (MD-MT)....lets's try (MT-MD).
- 1470 WKMP MI FLINT - 7/7 2032-2038 ABC news, ID, local news then "More of the best country on WKMP," poor u/GHOW. (DC-ON)
- WGBU PA FARRRELL - 7/23 2030 surfaced w/Top 40 music, ID, logged for call change, ex-WFAR. (JP-ON)
- 1490 KBAB IA INDIANOLA - 9/2 2130 fair in WOPA null w/ID, Ae news.(RK)
- WZOE IL PRINCETON - 8/7 2219 good w/promo. (RK-IL)
- 1500 WKIZ FL KEY WEST - 7/16 2102 on top w/string of PSAs then talk on scientific research. (SK-FL)
- 1510 WAHT PA ANNVILLE - 8/29 1945 atop w/ID then sports, new log, I rate this toughest freq. here. (RM-PA) Directional west, can only hear 'em on their f/c here. (DS)
- WRUA PA MONROEVILLE - 7/23 2043 caught bits/pieces of this w/s/off u/CKOT. (JP-ON)
- 1520 WIBG NJ OCEAN CITY - 8/24 1935-1940 in for first time o/WKBW w/ Sinatra type music, thought I was dreaming when I heard ID, sure wish they were back on 990! (RM-PA) I don't, makes my old WIBG surveys worth somethin'! Isn't their format still country? Were you dreaming? (DS)
- WNMT GA GARDEN CITY - 8/27 2014 w/s/off, SSB, fair next to super splash local WQCC. (SHP-NC)
- WINW OH CANTON - 8/27 2029 w/s/off, no SSB, booming o/WKBW.(SHP)
- 1530 WRBX NC CHAPEL HILL - 8/24 1930-1935 alone atop freq. w/bluegrass CW music, ads, female anncr., ID's, many NC mentions.(RM)
- WDJZ CT BRIDGEPORT - 8/25 1945-1957 jazz, ID's, PSA's. (TF-PA)
- 1540 WMLM MI ST. LOUIS - 8/3 2035-2045 weak w/CW music and live reports from local fair, long sought here. (JP-ON)
- WYRD NY E. SYRACUSE - 8/16 2007-2015 hymns, ID, way o/WPTR. (TF-PA) You heard WEIRD, huh? No wonder they requested new calls.(DS)
- 1550 WOKJ MS JACKSON - 8/27 2044 w/Jackson Today spot, ID, 1st time heard since moving from LA, super next to Cayman-1555.(SHP)
- WCGR NY CANANDAIGUA - 8/22 2000 managed to wrench clear ID from sundown mush, every once and a while here. (RM-PA) A likely candidate for a tiolet paper verie! (DS)
- WBZQ NC GREENVILLE - 8/23 1945 atop w/s/off, no SSB, have logged all the Greenville stations now, I'm sure you care.(RM-PA)
- WKBA VA VINTON - 9/1 1930 atop w/s/off by CE, I think it was the same guy who ran the weird ET a year back. (RM-PA) How cum you were the only guy who heard dat? (DS)
- WXVA WV CHARLESTOWN - 7/23 2048 fair w/CBE w/apparent s/off, anncr cut into record and said "I'm sorry but I've just been informed that we have to leave the air" then carrier was cut. (JP-ON) Nice n' legal! (DS)
- WUTQ NY UTICA - 8/21 2000 jingle/ID, fair signal. While flicking the dial, I came across this one. (WPT-DC) Flicking is fun, isn't it? (DS)
- WMOO AL MOBILE - 7/19 2018-2030 s/off w/religious format. (SK-FL)
- 1560 WSBV VA SOUTH BOSTON - 8/23 2015 o/WQXR w/s/off, no SSB. (RM-PA)
- WBKC OH CHARDON - 8/23 2030 just squeaked past WQXR w/weather for Chardon and Lake County. (RM-PA) Mouse radio. (DS)
- WYZD NC DOBSON - 8/19 2015 s/off w/male annc'r, clear ID, fair signal, track fast. (WPT-DC)
- WYSE FL INVERNESS - 7/19 2008-2015 in well w/CW music, s/off w/ no SSB. (SK-FL)
- 1570 CHLO ON ST. THOMAS - 9/5 2358 talk of Canada w/woman, ID at mid-night then music by the Eagles. (NAP-AL)
- CFOR ON ORILLIA - 8/27 2050 surprised to hear this one w/no sign of usual CKLM, good signal, consistent, many spots, ID. (SHP-NC) Very loud here lately. (DS)
- WFRL IL FREEPORT - 8/27 2058-2059 w/Gordon Lightfoot song, s/off w/mention of WXXQ FM, in CFOR null. (SHP-NC)
- KMYZ OK PRYOR - 8/27 2113-2115 w/weather, s/off, first time heard, even when I lived in TX! Weak but there. (SHP-NC)

1580 WKUN GA MONROE - 9/5 1937 in briefly w/man giving ID, mentions of GA, w/WAXU nulled but others there. (NAP-AL)
 UNID 9/5 2015 s/off w/2 ID's noted, SSB. IRCA Almanac shows WSSL here but ID's sounded like WSL. Forgot to put tape machine in record so missed the magic of this moment. This on the NRC convention Sat. nite, were you guys putting pins in the Perdue doll? (NAP-AL) No, we were playing hearts....(DS)
 1590 WHPY NC CLAYTON - 8/26 1935 atop w/CW music, followed by plug for Clayton H-S football. (RM-PA)
 1600 WCPK VA CHESAPEAKE - 8/22 1935 atop w/PSA, ID, then muzak. (RM)
 WAYC PA BEDFORD - 8/24 xlint o/WINX w/ID. (WPT-DC)
 WNEU WV WHEELING - 8/22 1953 xlint in WINX null w/weather, ment. of song by Squires. (WPT-DC)

MIDNITE - MIDDAY:

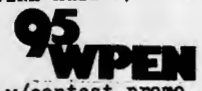

560 KLVI TX BEAUMONT - 9/6 0040 in nicely w/contest promo, ment's of Houston/Beaumont, 2 good ID's, CW music, slight bit of WHBQ. (NAP-AL)
 KWTO MO SPRINGFIELD - 9/2 0153 good in semi null of WIND w/CW music, ID, have been after this sucker for a while. (RK)
 580 CKAP ON KAPUSKASING - 8/24 0140 strong/alone w/CW music show aimed at truckers, formerly off MM's. (JF-ON)
 WTCM MI TRAVERSE CITY - 7/5 0501 good w/NBC news, ID, weather.(RK)
 590 WDLF FL PANAMA CITY - 9/6 0045 good w/WPLO nulled, some fading, male announc'r w/ID. Another one there but UNID, is WRAG fulltime? (NAP-AL) Better stay off that Irish coffee.(DS)
 620 UNID 9/2 0200 pop/progressive music noted here but gone before ID'ed, help? (CG-TX)
 WSUN FL ST. PETERSBURG - 7/17 0015 "Your Country, 62, S-U-N" ID noted. (SK-FL)
 630 KXOK MO ST. LOUIS - 9/6 0105 talk and ID w/WLAP nulled then Cuban took over. (NAP-AL) Tell it to the FBI! (DS)
 CPEK ON HUNTSVILLE - 8/22 0245 atop briefly w/CPEK/CFBQ ID's, weather, rock music. (RM-PA) 8/30 0138 way atop w/rock music, weather, ID. (DS-DE) Note correct call, Rem.
 680 WPTF NC RALEIGH - 7/17 0000 w/ID, NBC news, no sign of WAPA. (SK)
 690 WELD WV FISCHER - 8/27 0245-0258+ fair on ET w/Bluegrass music, ID'ed 0255, Cuban nulled. (DS-DE)
 WZAP VA BRISTOL - 8/1 0149-0204 ET w/Elvis music, giving as many as 12 ID's in a row, weak but alone. (DC-ON)
 710 CJRN ON NIAGARA FALLS - 8/30 0134 smashing WOR w/MoR/rock music, mentioning Nightline talk program starts 8/31. (DS-DE)
 800 CBQ ON THUNDER BAY - 8/9 0256-0300 in french w/news, sports, ID then gone, poor in CKLW null.
 WTMR NJ CAMDEN - 9/13 0045-0200+ evidently running another ID less OC/ET this AM, way over PJB/CKLW, while lining up this messterpiece column! (DS-DE)
 850 WRUF FL GAINESVILLE - 9/6 0200 sports, full ID, "85-RUF" slogan, lite rock, WYDE nulled. (NAP-AL) Couldn't sleep tonite or the bugs drag you out of bed? (DS) 8/24 0200 strong ending NBC news, ID, mention of "Gator Rock." (JF-ON) How'd Perdue miss that? (DS)
 910 WORD SC SPARTANBURG - 8/9 0414-0417 suddenly appeared w/female announc'r, Top 40 music, then gone on slightly auroral MM.(DC)
 WFDF MI FLINT - 7/8 0158-0201 soft instr. music, ID then CBS news, poor w/CHRL. (DC-ON)
 930 WPAT NJ PATERSON - 8/24 0231 caught ID during some kind of tele-talk show. (JF-ON) WPAT runs EZL/Doctors office music.(DS)
 950 WPEN PA PHILADELPHIA - 8/28 0055 off this AM leaving WKAZ usually loud. Also off MM 8/31. (DS-DE)
 WWJ MI DETROIT - 8/30 0142 way atop WPEN w/news, weather w/severe storm warning, maybe on day power. (DS-DE)
 960 WHYL PA CARLISLE - 8/31 0036 ID noted weakly on fadey OC, seems to run ET's alot on MM's after 0000. (DS-DE)
 980 WRC DC WASHINGTON - 9/6 0328 noted w/local/national news, very clear ID, time check, phone in show, WSIX nulled. (NAP)
 1060 WHFB MI BENTON HARBOR - 9/7 0010 s/on while sitting here looking for a Med. Fly that got in the radio, giving many ID's, location, power, et al. Very good over KYW. Enjoyed this as my 1st MM ET heard here. (NAP-AL) After you hear 'em test every week, that fad dampens quickly! (DS)
 1130 KWKH LA SHREVEPORT - 7/12 0627 on top w/promo. (SK-FL)
 1140 KGEM ID BOISE - 8/23 0250 fair w/mucho CKOC splash, w/Country 11 ID, CW music, 1st time heard in years. (RK-IL)

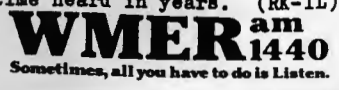

1150 WYNE WI KIMBERLY - 7/30 0131 good w/local bank ad. (RK-IL)
 WJBO LA BATON ROUGE - 7/12 0628-0638 w/rock music, ID, etc. (SK)
 1230 WTGJ IN TELL CITY - 8/25 0021 good w/news. (RK-IL)
 WECK NY CHEEKTOWAGA - 8/7 0511 weak in mess w/weather by female announc'r, was my closest unheard. (JF-ON) Mine, too. (DS)
 1240 WSEW PA SELINGSGROVE - 8/17 0530 detailed s/on, verified. (TF-PA)
 WRTA PA ALTOONA - 8/17 0530 noted w/local news, w/WSEW. (TF-PA)
 WWDW NY SCHENECTADY - 8/24 0545-0557 noted w/oldies, ID's as "5WD, your oldies station." (TF-PA)
 WJON MN ST. CLOUD - 9/3 0059+ good in WSBC null w/promo, ID just before WEDC s/on and wiped them out. (RK-IL) I've been wiped out, but not by WEDC! (DS)
 WMFG MN HIBBING - 8/3 0100-0130 good on ET w/rock music, asking for calls. Good thing WBEW wasn't on! (JF-ON)
 KWLC IA DECORAH - 8/23 0000+ fair in WSBC null w/news, ID. (RK)
 KICD IA SPENCER - 8/4 0028 fair in partial WSBC null w/ID, PSA.(RK)
 1290 WFBG PA ALTOONA - 8/13 0218-0237 w/weather, announc'r Dave Anthony, Top 40 music, poor w/CJEB/WBEP. (DC-ON)
 WVOW WV LOGAN - 8/23 0005-0008 w/UPI news, music ID, weather, religious items, 1st time heard here. (MT-MD)
 1310 WGH VA NEWPORT NEWS - 8/24 0300 alone on freq. w/AT-40, seldom heard at night here, I guess it is off MME. (JF-ON) Not any more, NSP I Believe. (DS)
 1330 UNID 8/25 0600-0614 noted program "Ramblin'w/Lazinski and Blumberg", Hindu Fertility Chants program, commuter delay report for 3rd Avenue El., conditions for Hugo O'Hara's Flatbush Two Foot Long Hoagie Shop, is this WPOW? (TF-PA) No, sounds like WFRT....(DS)
 1340 WNCO OH ASHLAND - 8/2 0226 on top w/CW music. (JF-ON)
 WMID NJ ATLANTIC CITY - 8/24 0306 fair, ending NBC news, local news. This station is quite regular here despite distance and CKDK. (JF-ON) Day regular here. (DS)
 WRAP PA READING - 8/29 0420 heard
 , so there! (ELK-ON) Right on! (DS)
 1350 UNID 8/29 0008 Canadian here after WZIX s/off w/GSQ til 0010 then OC stayed on, leaving WNIS w/Larry King. (DS-DE)
 1390 WMPO OH MIDDLEPORT-POMEROY - 8/23 2000 fair-poor in WVON null w/fool ID. (RK-IL)
 WGWY MI CHARLOTTE - 8/23 2045 poor u/WVON w/s/off. (RK-IL) We won't mention their in the wrong section....(DS)
 1400 WRDB WI REDESBURG - 8/11 0031 good w/Brewers Baseball, ID. (RK-IL)
 WMZK MI DETROIT - 7/13 0100 fair w/s/off. Was NSP under old WJLB calls, maybe they go off now? (RK-IL) Guess they did if you heard them go off.....did you have the radio on this AM? Or this PM? (DS)
 CKOB ON RENFREW - 8/9 0010-0015 popped up from mess w/female reading s/off, "Oh Canada", et al. On late? (DC-ON)
 1450 KBMW MN BRECKENRIDGE - 9/1 0108 fair w/ID in WXOL null. (RK-IL)
 WJPA PA WASHINGTON - 7/1 0105+ fair w/full ID. (RK-IL)
 1460 WCMB PA HARRISBURG - 8/24 0320 on top w/CW music, seldom heard here. (JF-ON) A quote from Dave Fox, Reading, PA.: "You should be so lucky!" (DS)
 1480 WJIT NY NEW YORK - 8/9 0201-0222 in Spanish w/possible news, ID's and L-A music. CKAN/WHBC off. (DC-ON)
 1490 WANA AL ANNISTON - 8/16 0118 fair w/PSA. (RK-IL)
 KRIB IA MASON CITY - 8/16 0159+ good w/s/off. (RK-IL)
 WOPA IL OAK PARK - 8/16 0200-0410+ on a very rare SP this AM, some TT/OC. (RK-IL)
 WOMI KY OWENSBORO - 8/17 0150+ good w/promo. (RK-IL)
 KLGR MN REDWOOD FALLS - 8/17 0158 fair w/s/off w/SSB. (RK-IL)
 KYNW NE OMAHA - 8/22 0235 fair w/ID. (RK-IL)
 WOPI TN BRISTOL - 8/22 0258 good w/promo & full ID. (RK-IL)
 WITA TN KNOXVILLE - 8/23 0517 good w/ID then gone. (RK-IL)
 KTTR MO ROLLA - 9/5 0105 good in WVON null w/s/off w/SSB. (RK-IL)
 WJNL PA JOHNSTOWN - 8/31 0006 s/off noted for AM & FM w/SSB, female announc'r. (DS-DE)
 WESB PA BRADFORD - 8/11 0009 very weak in mess w/ID. (JF-ON)
 1500 WTOP DC WASHINGTON - 9/1 0040 noted off this Tuesday AM leaving WLQV at a fair level. (DS-DE)
 1540 KXEL IA WATERLOO - 8/28 0014 w/religious program from Dallas, ID 0015, KTIA faint beneath. (SHP-NC)
 KEDA TX SAN ANTONIO - 9/2 0100 ET w/some spanish talk between LA music. (CG-TX)
 1550 WCGR NY CANANDAIGUA - 8/23 0615 half a s/on before signal faded, frequent visitor. (TF-PA)
 1560 WQXR NY NEW YORK - 8/28 0005 w/news, Sheraton Hotel ad, good o/u WDXR. (SHP-NC)

- 1560 WTAI FL MELBOURNE - 7/12 0643 w/CW music, ID's, ads. Heard twice in CA, never answered either report so another try. (SK-FL). Couple of reports brought a vague v/l. (DS)
- 1580 WLIM NY PATCHOGUE - 8/23 0602-0614 detailed s/on, instr. SSB, big band music, already varied. (TF-PA)
- 1590 WFLM PA CARNEGIE - 8/23 0600 detailed s/on "to praise and thank the Lord for his blessing." (TF-PA) And the money, too!

WHO CARE'S DEPT.:

WUBE goes to the Music of Your Life format 9/5, dropping CW.

Jerry Starr mentions WHOT-1330 was running non-DA on MM 9/14. We'll know next column who heard them.

DAN BARTEK is the very proud owner of the official NRC DX WORM which he unknowingly bought at the auction! I wonder what KEN CHATTERTON will do with all the stuff he bought, enough to fill a truck! Will I make it to Louisville in '82? Will ELK ever find out that the reason his radio doesn't work is because it's not plugged in? Questions, questions...

ON THE POLICE BLOTTER THIS WEEK:

- | | | |
|--------|--------------------------------------|-----------------------------|
| NAP-AL | Neal Perdue, Falkville, AL | RF2200, SM2 |
| JS-OH | Jerry Schtarr, Huebard, OH | HQ180, Looped |
| RK-OH | Rroobbeertrt Kkrraameerr, Chic., Ill | R1000, HQ129X, R. West Loop |
| TF-PA | Tony Fitzherbert, Chalfont, PA | DX60, LW |
| CG-TX | Charles George, Dallas, TX | |
| ELK-OH | Ed Krasjny, Middleburg Heights, OH | Zzzzz, Adelman Loop |
| RM-PA | Rem Murphy, Roslyn, PA | DX160, SM2 |
| JF-ON | Jeff Falconer, Clinton, ON | NRD 515, TRF, SM2, LW |
| SHP-NC | Steve Ponder, Mathews, NC | TRF, Wedge Loop |
| WPT-DC | William P. Townshend, Wash., DC | TRF (Batteries included) |
| DC-ON | Dick Clark, Bandstandville | TRF |
| SK-FL | Steve Kemp, Hollywood, FL | ICF 5900 W, ICF 2001, ICFU |
| MT-MD | Mike Tuggle, Bel Air, MD | Fancy Xtal radio, LW. |
| DS-DE | Who'd you expect, John Daller? | HQ180, Superadio, SM2 |

Looking forward to another swingin' year with DDXD! Next deadline in 2 weeks!

SEE YOU IN NUDE JERSEY.

73's & Good DX!



THEY JOINED

Welcome to the following new members. Muse soon and introduce yourselves.

- George Hakiel, 739 Van Buren Ave., West Islip, NY 11795
- John R. Malicky, 995 Shadycrest Rd., Pittsburgh, PA 15216
- Bob Milne, P.O. Box 504, Hackensack NJ 07601
- Ben Peters, Lynbaansgr. 318', 1017 WZ AMSTERDAM, HOLLAND
- Bruce R. Kampe (WA1PO1), 10D Dayton Court, Newington, CT 06111
- David L. Spraker, 9-5 Latham Village Lane, Latham, NY 12110
- Paul Zehr, P.O. Box 573, Ely, NV 89301 (Rejoins)
- Bill Menke (K2SUG), 923 East State St., Ithaca, NY 14850

The following members recently renewed membership in the BEST DX Club:

- Jerry Starr, Russ Edmunds, John Brandel, Kurt Nelson, Glenn Thompson, Ronald Dennhardt, G. Hoare, Tim Kerfoot, Bill Grant, Joseph Machala, Bryan Griffiths (2 yrs.), Bill Bergadano, Morris Sorensen, Brett Hanavan, Joe Fela, Wayne Murphy, Tom Walsh, Artie Bigley, Peter Nolan, Frank Aden Jr., John Sampson, Roger Anderson, Paul Crowder, Al Merriman, Rem Murphy, Jim Gangler, Thomas Holmes, Roger Giannini, Ethel & Norman Parsons, Ian Harris, Robert Larsen, Yves Morissette (2 yrs.), Konstantine Rychalsky, Robert Karchevski, Charles Hutton, Darryl Belanger and Alfonso Bedoya!! Thanks for helping to make the NRC the organization for BCX DXing.

INTERNATIONAL DX DIGEST

CHUCK HUTTON
P.O. BOX 2087
DECATUR, GA 30030
(404) 633-1198
BEFORE 2300 ELT

Times are GMT. For ELT subtract 5 hours. Deadlines are usually Monday.

This round I am really going to get an early jump on IDX. First order of business is the half-page or so held from the last issue. (Sounds like old BPC doesn't it?)

- 1020 VENEZUELA La Ascuncion YVRS 8/8 xlnt w/Mundial Margarita ID. (Connelly)
- 1040 COLOMBIA Baranquilla HJAI 0459 8/8 CARACOL ID atop rumble. (Connelly)
- 1080 HAITI 4VRD Port-au-Prince noted w/WTIC weakened by phasing null w/ID as R. Nacional de Haiti in FF then NA at 0500. (Kazaross)
- 1090 VENEZUELA YVRSZ Caracas in well in tough-to-maintain phase null of WBAL w/Exitos Mil Noventa ID, electronic sounds and into disco mx 0505 7/24. (Kaz)
- 1091t COLOMBIA Monteria 0500 8/8, het. (Connelly)
- 1100 ANTIGUA ZDK is noted every night with WWWE looped or phased, oftwn mixed with HJAT. Very good at 0112 7/12 w/TC and count-down of the top songs of the week. (Kaz)
- 1100 COLOMBIA HJAT Barranquilla 0506 8/8 good w/slow SS ballad, R. Reloj ID. Cx for South America were mediocre w/only the usual big guns making it through storm QRN and domestic station QRM. (Connelly)
- 1110 VENEZUELA Carupano YVQT xlnt w/"en Carupano" ad at 0049 7/12. (Kaz)
- 1120 CUBA Artemisa R. Habana Cuba fair 0400 7/28 w/ID. KMOX phased. (Thomas)
- 1130 DOMINICAN REPUBLIC Santiago R. Exitos fair but with good ID at 0255 7/28. Operatic SS mx seemed to be main programming. KWKH phased. (Thomas)
- 1140 CUBA Arroyo Arenas CMEW //1160 w/Cadena Habana pgm, poor in mess u/WRVA 0211 7/7. (Kaz)
- 1170 HAITI Port-au-Prince 4VRS fading o/YVQV w/accented FF talk 0057 7/12. (Kaz)
- 1170 VENEZUELA Acarigua YVQV in w/SS talk about Venezuela and Acarigua 0056 7/12. Occaasionally noted early eves. (Kaz)
- 1210 DOMINICA noted in well in FF w/WCAU phased 0040 7/24. (Kaz)
- 1223.7 UNID someone here hetting TIPJ (1224.4) 0245 7/15. No ideas. (Thomas)
- 1251 UNID strong het, bits of talk by woman (possibly FF or AA, too much slop to be sure which) 0349 8/6. (Connelly)
- 1259.5 UNID carrier only 0309 8/8. (Thomas)
- 1261.3 UNID carrier here 0310 8/8. (Thomas)
- 1303.6 UNID just caught the "buenos noches" then carrier cut 0403 8/8. (Thomas) I was unsuccessful the last couple months of last season on this fellow-CH
- 1315 UNID weak carrier here 0250 7/18 in R. Bani null. Looped SSE but only thing listed is HCCP3 at 250 watts....mmmm. (Thomas)
- 1328.4 MEXICO (but who?) very lively LA mx and many mentions of Mexico (loop agrees) 0345 8/8. (Thomas)
- 1353.0 GUATEMALA Coban R. Monja Blanca fair at s/off 0332 7/14 with ID and soft mx close (no NA). New here. (Thomas) Well... I had R. El Patio, La Ceiba, Honduras here. A new station here or a mistake by one of us?
- 1371 UNID LA het (HIFA?) 0430 8/5. (Connelly) Yep-CH
- 1383.8 UNID a regular here now w/SS male dialogue and frequent mentions of Guatemala (and other CA countries) but never a readable ID. Noted again 0330 8/8. (Thomas) R. Constelacion, Honduraa was here last year-CH

834 BELIZE R. Belize 8/27 0231 strong with telephone talk pgm. Announcer had thick Caribbean accent. (Falconer)

854 UNID 8/24 0607 fair carrier was noted here looping SA. Was hoping for another rare appearance of Peru. (Falconer)

860 MEXICO R. Universidad XEUN, hrd classical mx 0330, 0400 world news, 0415 a play. 8/19 good covering KKOW. (George)

864t FRANCE female AA chant to fair peaks; poor cx precluded checking other France Culture net freqs for //s, 0418 9/9. (Connelly)

910 VENEZUELA YVRQ R. Aeropuerto, Maiquetis on top 8/19 0005 w/ID, ads. (Kamp)

915 UNID 8/27 0130-0145 an unid LA here w/fair sig looping CA and had several soft instrumental and vocal selections. ID was given at 0140 but modulation was too shallow for copy. (Falconer) Gerry Thomas says it's the Ecuadorian. They have surely raised power as they are there almost nightly in the shadow of my 920 local whereas last year they were buried. CH

920 CUBA CMDJ Cardenas 8/24 0611 weak u/mess w/usual Reloj time ticks. (Falconer)

1035 HAITI hVEC Cap Haitien in fair 8/19 2354 with EE rel. (Kamp)

1045 UNID 8/27 0120 fairly strong carrier with bits of LA type mx surfacing at times. Have been trying to get a positive ID from the Panamanian for years with no luck. (Falconer)

1100 ANTIGUA ZDK St. John's in poor most nights 2340 with "ZDK Community Calendar"; lost to HJAT by 0000. Noted on top 8/20 0121-0137 w/ads, ID's. (Kamp)

1100 COLOMBIA HJAT R. Reloj on top most evenings after 0000 with Reloj time checks, etc. (Kamp)

1107t CAMEROUN Douala 2345 9/7 w/West African chanting and drumming. Male anncr in vernacular I couldn't comprehend. Peaks were 8-10 dB above noise. Later several SS stations on the freq started overwhelming. Multiple SAH's of 2-16 Hz. Then 9/8 station dominated freq and male delivered his sing-songy ovation for about 50 minutes, 2305 to 2354. 44 dB o/noise on peaks. SS stns then gave him tremendous competition. All stations seemed to s/off at 2400 w/o NA. Only GG stn heard later. 9/9 at 2210 SW // 4850 KHz had program similar to that I heard on 1107 9/7 but had FF female anncr. S/off was with anthem at 2300 but in tuning 1107 from 2210 to 2330 only SS stations were heard. (Bailey) An entertaining catch-CH

1120 CUBA CMCW R. Cadena Habana mostly o/KMOX 8/12 at 1024, // 1160 KHz. (Kamp)

1165 ANTIGUA Caribbean Radio Lighthouse in well 8/19 0023-0048 w/Lighthouse Stages request pgm, Bible reading 0049-0100, ID at 0100 followed by religious pgm. Usually has a better signal than ZDK. (Kamp)

1170 HAITI hVRS R. Soleil presumed the one here w/FF pop mx request pgm 0010 8/19. (Kamp)

1377 FRANCE Lille fair w/man and woman in FF thru WBNX slop 0426 9/7. (DeLorenzo)

1403.3 UNID 8/17 0340 strong carrier here with bits of audio. Perhaps Guinea is off freq again. (Falconer)

1408 UNID potent OC here-Conakry drifting again? 0430 9/9. (Connelly) A popular line this issue-CH

1485 SPAIN commonwave outlets-SS talk to good peaks 0503 8/29. (Connelly)

1530 VATICAN R. Vatican really doing a tap dance on WCKY; theme mx (often heard before), clear Vatican mention then into apparent GG talk by man and woman-sometimes totally dominant 0345 8/18. On several other nights Vatican has been noted just a bit behind WCKY; also a domestic has been tossing OC's o/WCKY before the legal 0400 ET time. (Connelly)

1540 BAHAMAS ZNS1 Nassau in regular days in Broward County w/little slop from WRHC-1550 in Coral Gables; not true in Key Biscaine. (Kamp) Noted w/tremendous signal, usual fare at 0041 8/27. Interesting spot for All-Day Party at Goodman's Bay by anncr. (Ponder)

1555 CAYMAN ISLANDS R. Cayman noted w/booming signal plus good modulation w/cl mx concert 0049 8/27. (Ponder) In fair 8/17 0017 w/Sunday Request Program. (Kamp) 8/27 0229 strong w/disco and calypso mx and ad for Budweiser. (Falconer)

1557 UNID (France or Malta) AA chant then AA talk; loud 0420 8/29. (Connelly)

1403.3 GUINEA Conakry producing fair audio 0619 7/14. (Thomas)

1404 GUINEA Conakry poor w/shouting at low audio level 0513 8/8. (Connelly)

1476t AUSTRIA light mx poor 0308 8/1. (Connelly)

1494 UNID France? TT'er 0412 8/1. (Connelly)

1505t ECUADOR Loja presumed the one given DF and mention of Ecuador. Gave freq as 1505 at 0500 8/3 so not a drifter. No slogan heard. (Thomas)

1530t VATICAN FF talk, possible Vatican mention looping TA, u/WCKY 0306 8/1. (Connelly)

1557 FRANCE Nice poor w/man and woman in FF (bad T-atorm QRN) 0328 8/6. (Connelly)

1566 SWITZERLAND Sarnen poor (fading like crazy), uptempo instrumental, man in GG 0400 8/1. (Connelly)

1566 TUNISIA Sfax suspected w/OC before s/on, 0410 8/6. (Connelly)

1584 SPAIN Elche EAJ53 fair-good w/R. Elche ID by SS man 0502-0506 5/10. This was above stn w/SER nx. At least a carrier is noted on this freq many nights. On this night this was the only TA giving good audio. (Kaz)

1584 SPAIN two audios here weakly w/SER nx mixed w/SS mx 0420-0423 7/7. (Kaz)

1593 WEST GERMANY Langenberg loud w/nx by man in GG 0302 8/1. 1539 was whipping a mean het on WPTR at the time. Fluttery w/light mx in storm QRN 0337 8/6. (Connelly)

1610 ANGUILLA good w/religious mx 0500 7/14. (Thomas)

And now, on to the stuff that is really for this issue.....

549 ALGERIA Oran noted w/chant-carrier fair, audio poor 0358 9/9. (Connelly)

580 CUBA CMAA Pinar del Rio looped from domestic--8/12 0054 political commentary by man in SS. (Kamp)

600 CUBA CMXK San Antonio de las Vegas booming in 8/12 0055 w/Radio Moscov North American Service. (Kamp)

612t MOROCCO strong carrier, no audio heard 0403 9/9. (Connelly)

639 SPAIN La Coruna poor w/nx in SS 0406 9/9. (Connelly)

640 COLOMBIA HJBJ at 0703 9/9 the old familiar RGN spot was hrd along with many mentions of Colombia so suspect HJBJ was the one. Poor during Cuba fade. (Kowalski)

640 GUATEMALA TGW R. Nacional, hrd marimba mx along with the Colombian and Cuban mx and at 0717 9/9 was rewarded with an anncr ID'ing and a dozen mentions of Guatemala. Fair during Cuba fade. (Kowalski)

650 CUBA rarely heard outlet here fair to good w/SS vocals // 640; o/u WSM 0426 8/29.

690 ANGUILLA Caribbean Beacon 7/25 0125 fair o/u Cuba w/religious pgm, //1610 but not as strong. (Falconer)

698.9 DOMINICAN REPUBLIC R. Mao HIDC Valverde 8/27 0200 strong w/SS talk and ID at top of hour. Had loud het on 700. (Falconer)

700 COSTA RICA TIHB San Jose 8/27 0202 weak o/u unid LA, no WLW w/many mentions of Costa Rica by excited announcer. (Falconer)

724.9 COSTA RICA TILX San Jose 8/17 0330 was likely the strong LA noted here in passing. (Falconer)

756 WEST GERMANY Braunschweig fair w/man in GG 0412 9/9. (Con)

760 COLOMBIA HJAJ LV de Barranquilla on top 8/12 0138 with Latin mx, slogan ID's. Usually dominates channel at nights over daytime regular (on car radio!) R. Reloj. (Kamp)

810 BAHAMAS ZNS3 Northern Service, Freeport regular both days and nights in Broward County; in Key Biscaine about 25 miles to the south ZNS3 is never heard at night! (Kamp)

810 COLOMBIA HJCY Bogota 8/27 0110 very strong and alone on freq w/SS discussion between 2 men, also had many Suta-tanza mentions. (Falconer)

825 ST. KITTS R. Paradise Basseterre 8/27 0115 very strong (20 o/S9) w/usual religious pgm. (Falconer) Hrd with good level thru the noise at 0412 8/29 for my first new stn in 5 1/2 years due to inactivity (I should say so-CH). Pgm was "Songs in the Night"-C&W favored religious. (Sullivan)

830 DOMINICAN REPUBLIC HIJB Santo Domingo on top 8/17 0222 with soft rock, ID's. (Kamp)

830 VENEZUELA YVMT R. Sensacion snuck thru HIJB with ID 8/17 at 0250. (Kamp)

- 1557t FRANCE man and woman in SS-carrier strong but audio garbled by ferocious WQXR splash 0443 9/9. (Connelly)
- 1566 TUNISIA Sarnen fair through CKLM slop; GG pop vocal, GG talk, Dixieland jazz, 0410-0420 8/289. (Connelly)
- 1566 TUNISIA Sfax xint w/AA chant, drums 0446 9/9. The signal was so massive that despite Sfax's very low modulation level the AA mx was easy listening quality. (Connelly)
- 1575t ITALY II-sounding operatic style pop vocals 0406 8/29. (Connelly)
- 1584 SPAIN locals-2 stations, both w/SS talk, battling it out o/s host of other co-channel signals 0501 8/29. (Connelly)
- 1593 WEST GERMANY WDR Langenberg 16c with man in GG, Dixieland jazz 0409-0415 9/7. (DeLorenzo) Good, although fluttery w/rock mx 0340 8/18. Xint (like a local) w/woman in GG 0402 8/29. (Connelly) 8/17 0445 fair w/cl mx with high-pitched woman vocalist. (Falconer)
- 1610 ANGUILLA Carribean Beacon in fair 8/17 0107 w/vacation resort ads. (Kamp) "Your Family Station" hrd w/religious mx 0219 for country 45. And all I was trying to do is check out the top end tuning of my loop. (Sullivan) (So now go check out the bottom-end tuning and the mid-band tuning, etc., hi-CH) 8/27 0245 had ID "Music until midnight on the Caribbean Beacon" then into country gospel mx. (Falconer) (They were wrong, that's not music.....) Fair-good w/gospel mx, EE ID 0205-0230 8/13. (DeLorenzo)

And that is all... Glad to see the influx of reporters as the new season starts. In particular welcome back to Phil Sullivan who sure has remained well hidden for years. As for myself I did not turn the radio on for four months (MW is not a band for all seasons to make a lousy pun) but 2 checks last week showed things are under way for the fall season. You guys should hear: the Guatemalan on 808.5; he is nightly here and a piece of cake on Florida beaches with a TRF. There's also Angulo (Cuba) on 1328.4, not listed anywhere. The Ecuadorian on 915 is going to be heard by a few-he seems to have as good a signal as any other HC. TA-wise just the tired old regulars of the last 4 years. Might as well resign myself to waiting another two years or so for the real action to begin. REPORT! Send all complaints to Dave Schmidt!

Bill Bailey-Holden, Mass.	2 pairs of 1200' phased Beverages, R390A
Mark Connelly-W. Yarmouth, Mass.	R390A, RF2600, SM2, 2 37m. phased LW's
-BillERICA, Mass.	HQ180A, MW1
Bob Curtis-Colchester, Vt.	SP600, longwire
Marc DeLorenzo-Sudbury, Mass.	HQ100, SM2, 1w
Jeff Falconer-Clinton, Ontario	NRD515, TRF, SM2, 190' LW
Charles George-Dallas, Texas	RF2600, SM2
Steve Kamp-Hollywood, Fla.	ICF5900W, ICF2001
Paul Kowalski-Milwaukee, Wis.	Modified R1000, Radio West loop
Steve Paradies-Millville, N.J.	TRF, 100' LW
Steve Ponder-Matthews, N.C.	GC1A, GR78, TRF, Wedge, LW
Phil Sullivan-Acton, Mass.	HQ100, 3 foot loop
Gerry Thomas-Pensacola, Fla.	Modified FRG7, Comquest Superloop

continued from page 13

Any or all of the initial 24 issues of RADEX. (Carleton Lord, 12 Lower Dr., Corning, NY 14830)

BACK ISSUES OF DXN, Boston or prior issues for donation to the Temple U. Library (RJE)

Well, that's it, unless Dick has some other items to add. Next edition is anticipated for late October, so please get items in by about 10/15!

73's

RJE

Whoops! 1 late item just before I'm ready to mail:

WANTED -

WRTH, 1978-79-80 editions. Will pay reasonable price plus postage for copies in good ex, no missing pages. (Gene Nix, 428 Prairievew Dr. Apt. A, Gillette, WY 82716)

Greetings again, and welcome to another edition of DXChange. This somewhat-abbreviated edition is overdue, partly due to the paucity of submissions, and partly due to my preoccupation with Convention preparations. For both eventualities, I apologize.

FOR SALE - RECEIVERS

HAMMARLUND HQ-180, with clock, manual, \$220, transportation negotiable. (Neil G. Zank, P.O. Box 5563, Lincoln, NE 68505)

REALISTIC DX-160, 3 yrs. old, but good as new, w/ vernitron filters for improved sensitivity (as in Hutton-modified TRF's), with matching spkr. \$100 plus shipping UPS. (Rich Kenneally, 8132 Ashgrove Dr., Cincinnati, OH 45244; 513-474-1460)

ZENITH Royal D7000; LW, MW, FM, VHF weather, 7 SW bands. Exc. ex. \$325 or best offer. (Paul Wardell, 2104 SE 28th Pl., Portland, OR 97214; 503-236-0826)

YAESU FRG-7 with Radio Mods; 2.9 khz. mechanical filter and also digital readout (outboard). Mint condition- sold new for over \$550. 2 years ago. First \$300. takes it, plus UPS shipping. (Dick Truax, 3003 Gleeson Ln., Louisville, KY 40299; 502-491-2871.

FOR SALE - ACCESSORIES

J. C. PENNEY portable cassette tape recorder. Exc. ex, \$20. Has level meter & control plus counter. (Keneally)

HEATHKIT HD-20, 100kc Xtal Calibrator with manual \$9. (Frank Aden, Jr., 4514 SE 83rd, Apt. 5, Portland, OR 97266)

FOR SALE - PUBLICATIONS

FM ATLAS - 3rd (1975), 4th (1976), 5th (1978) editions. \$1.75 eas. or 3/4.75 (Aden)

RADIO ELECTRONICS - Jan. & Feb. 1978, both for 75¢ (Aden)

HAM RADIO HORIZONS - First issue, 3/77. \$2. (Aden)

POPULAR ELECTRONICS - 8/78, 10/78, 12/78; 50¢ ea. or 3/\$1. (Aden)

RCMA NEWSLETTER, incomplete set 4/78-6/80, 20 issues total. \$2. (Aden)

WTFDA TV STATION GUIDE - 1975 edition, collectors item. \$3. (Aden)

WTFDA letterhead, approx. 200 sheets \$3. (Aden)

WTFDA station log pages, approx. 90 sheets \$1.50 (Aden)

WTFDA station report forms (TV) 90 sheets \$1.50 (Aden.) ((This and prior 2 items all for \$5))

SWL ADDRESS BOOK & updater (1969) plus SW BROADCASTS TO NA, Gilfer ca. 1970, collectors items, \$2.50 (Aden)

BROADCASTING, 25 issues, 2/78-11/78, incomplete set, \$7.50 (Aden)

COMMUNICATIONS WORLD, Fall-Winter '75; Spring-Summer '75; Fall-Winter '76; Spring-Summer 1977, 78; 75¢ each or all for \$3.25 (Aden)

ELEMENTARY ELECTRONICS, 5-6/75; 5-6/77; 3-4/78; 5-6/78; 7-8/78; 9-10/78; 11-12/78; 50¢ ea. or all for \$3.

THE FUN OF SW LISTENING (Buckwalter, 1965) & The SW Listeners' Guide (Woodruff 1973), collectors' items, both for \$2. (Aden)

WANTED -

HQ-180A, R-390A or modified FRG-7 rx. Must be in good-exc. ex, w/ manual, Will pay competitive prices. (George Santulli, 689 McCloud Ave., #205; Thousand Oaks, CA 91360; 805-495-7833) Will pay u So, Cal., or UPS otherwise.

SM-2 antenna, good-exc. ex, as above. (Santulli)

XTALS or info for obtaining same for HAMMARLUND HQ-180AX. (Harley Steward, 4220 French St., Erie, PA 16504)

RECEIVER REVIEW...THE ICF-S5W

By Paul Swearingen

Medium-wave DX'ers have been hoping that some company would produce an affordable, selective, and sensitive portable receiver as a worthy successor to Radio Shack's defunct Realistic 12-655, affectionately known as the TRF. GE's Superadio (7-2880B) at about \$60 seemed to be the logical choice -- indeed, the only choice -- until Sony unveiled its ICF-S5W in June, 1980, and introduced it to the U. S. market in August at an average price of about \$70-75.

The Sony Corporation claims that the Japanese version of the S5W became the most popular of Sony's portables in Japan. The Japanese version incorporates crystal reception of NSB (domestic shortwave channels) and the Japanese version of the "zone dial" listing key stations in selected zones on a rotating drum. The U. S. version divides the lower 48 into 10 zones (imprinted on the back of the RX) and lists key stations by call letters on the slide-rule dial -- clear channel stations in blue, others in green. FM stations are not zoned. (See the following articles in *DX News* for further description of the S5W: Vol. 4, #25-p. 29 and 32; #22-p. 18; #11-p. 16.) Otherwise, the Japanese and American versions are identical.

Sony decided to institute a unique monitor program to test-DX the S5W in the U. S. According to Jon Strom, U. S. Manager of Consumer Audio Product Planning, ten monitors were selected from 100+ applicants (nine accepted) from several clubs on the basis of (1) quality of letters of application, (2) broad geographical representation, (3) familiarity to Mr. Strom through their activities in DX clubs. Nine sets were shipped to monitors (including this writer) in early March, and the nine were expected to supply Strom with information about the performance of the S5W in comparison to other RX's. And, according to Strom, the overall "rating" of the S5W was "very good;" plus the monitor reports were of "great benefit" to him.

Will he offer other RX's for test-DX'ing again? Says Strom, "I hope to continue other receiver tests in this manner if my management approves it."

The S5W is apparently the first medium-wave receiver since some console models of the early 1940's to incorporate call letters into the dial. "We planned the zone dial as a means of getting average people interested in listening to distant stations ... a unique case of a manufacturer trying to promote the hobby of DX'ing," Strom said.

The monitors received the RX's with the stipulation that they would not modify the sets in any way. Reports from NRC monitors seem to indicate some inconsistent reception from receiver to receiver, indicating the need for internal adjustment for the S5W to achieve peak reception. Strom says, in addition, that Sony believes that the S5W's FET RF amp is "superior to a TRF." Further information in the form of a service manual and schematic may be obtained from Sony's Technical Publications Department: Sony Corporation / 10707 AirWorld Drive / Kansas City, MO 64153 / Attn.: Charlene Dougan. (Phone: (816) 891-7575).

Detailed reports in *DX News* from Mark Connelly, Gerry Thomas/Charlie Barfield, and others seem to give the unmodified ICF-S5W an edge in performance in AM and a nearly equal performance rating in FM tests, conducted on several receivers. With the availability of a schematic so that DX'ers can tweak the S5W and even modify it (Sony, of course, does not advocate any modification) for optimum DX performance, the S5W could easily put some non-portable and more expensive RX's into mothballs.

This writer's tests revealed similar results to those of the above DX'ers. A few other items of interest were revealed.

First, the switchable AM sensitivity circuit seems to "jump" the frequency up about 5 khz. at the lower end of the scale -- enabling me, with the switch in "low" position, to tune in another beacon below the normal range of the S5W, listed at 530-1605 khz., but more likely 515-1625 khz., and including at least one audible beacon at almost all times, just above the extreme bottom of the normal range.

As I live about 120 miles from the nearest population center (Kansas City) and almost 20 miles from the nearest transmitter, overloading of signals on both AM and FM is not a problem. I received the set too late in the DX season to make much of a test of its AM selectivity (it did separate 655-San Salvador and 834-Belize easily from adjacent stations), but I found that it easily separated signals on adjacent strong channels on both AM and FM; and weak signals were audible on channels adjacent to strong stations, without much splatter (superior to the HQ-180's so-called splatter factor).

A daytime bandscan (with the S5W both attached to a longwire/ground and unattached) revealed that the S5W pulled in several stations which the HQ-180, attached to a box loop, could not (including 730-KWRE, 770-WEW, and 1030-KTWO, with the S5W attached to a longwire), although the HQ-180 pulled in 830-WCCO and an unidentified signal on 1180.

With one bay of a 2-13 Channel Master antenna clipped to the TRF's antenna, the FM section of the S5W pulled in stations as far away as 255 miles (103.3-KJLS) and 235 miles (104.1-KOFM). With whip antenna only, I could hear 104.5-KKMA at 125 miles. FM performance is not to be sniffed at, either.

(continued on page 15)

INTERNATIONAL DX ACHIEVEMENTS

PAUL SWEARINGEN
P.O. BOX 500
MORAN, KS 66755

DX'er	Yr.	Location	Countries	T. V.	Asia -- Best Verie
Ray Crawford, 59		Australia	167 VAC	1627	359 FEN - 1500 Iwo Jima 100 w.
Hank Wilkinson, 30		California	79 VAC	510	123 JOID - 1470 500 w.
*Gene Allen, 40		California	65 VAC	2916	71 R. Sakhalin - 973 20 kw.
Hilding Gustafson, 34		Florida	109 VAC	857	14 1025 - Haifa, Israel 500 w.
Ben Dangerfield, 58		Pennsylvania	118 VAC	422	8 655 - Pyongyang, North Korea
John Callarman, ??		Illinois	50 VAC	740	6 JOAK - 1220
Roger Anderson, 38		Virginia	105 VAC	1448	5 786 - Damascus 10 kw.
Hank Holbrook, 46		Maryland	101 VAC	2453	2 764 - Baghdad, Iraq
Sid Steele, 31		Illinois	34	2967	1 JOAK-2 (1935)
Rick Carr, 75		Texas	41	1366	1 HLDA - 1566 South Korea
Frank Wheeler, 31		Pennsylvania	23	1725	-
Andy Rugg, 60		Quebec	60	1494	-
Rick Kenneally, 78		Ohio	41	1149	-
Ron Musco, 62		Connecticut	26	1045	-
Wayne Heinen, ??		Colorado	18	882	-
Mike Knitter, 74		Wisconsin	10	711	-
Paul Swearingen, 75		Kansas	21	464	- (HLDA - almost, hi!)
Niel Wolfish, 77		Ontario	11	397	-
Konstantine Rychalsky		Connecticut	12	289	-
*Eric Loy, 75		Illinois	3	65	-
Earl Higgins, 79		Illinois	7	60	-
Don Lynch, 60		Massachusetts	9	?	-

VAC = Verified All Continents; Yr. = year began keeping veries. ** Gene, your last update was in July, 1980, and I need an update so that I can continue listing your achievements. *Eric, I'll list you once more without an update. Thanks for updates from Rick Carr, Ray Crawford, Hilding Gustafson, Rick Kenneally, and Niel Wolfish. Note that Ray has moved from New Zealand to Australia on transfer with his company, which is in the aluminum smelting business. He's now using a Drake SPR-4 and plans to string up some 1w's in the bush. Watch out for tall kangaroos, Ray! The all-time achievements list is still on hold while other things come first. I didn't get much DX'ing done this summer, but I did repair my alleged beverage so as to be ready for the 1981-82 season. How about some of the active NRC's shooting me some updates? Include the following information: Veries or tapes only; tapes must include two out of three of call letters or slogan, frequency, location; no "heard's"; total veries (include domestics -- continental U. S. and Canada -- in your total count), total countries (incl. domestics), total foreign veries, North American veries (no domestics), South American veries, European veries, Oceanian veries, African veries, plus your best varied catch (or heard, but please say so) from each category. Include the year you started keeping veries, and you may indicate if you keep both taped and paper veries, but indicate any duplications -- your totals should reflect one verie from each station. Next IDIA: Africa, with total veries as the tiebreaker. Deadline: November 6.

Paul Swearingen

continued from page 14

I personally prefer the cleaner sound quality of the S5W to the Superadio's "booming" bassy sound. Its compact size is another factor. Placement of controls is not a problem, although I would recommend to Sony that they consider adding separate bass/treble pots -- with the clumsy slide pots eliminated, if possible. I would also ask for a 300-ohm antenna terminal to be added to the set, as GE wisely did to its Superadio, apparently in response to consumer demand. The white-on-brushed aluminum numerals for FM are a bit difficult to read, and the three LED's, while useful, are a rather poor replacement for a signal-strength VU meter. Other modifications could be made to improve the S5W, of course, but the cost would mount accordingly.

The S5W's problems are for the most part minor ones which do not really detract from its DX'ing performance, which I feel is the best for the money of any under-\$150 MW receiver.

16 RADIO WRECKED???

Bob Colegrove
5547 High Tor Hill
Columbia, MD 21045

Volume 48, Number 24 contained an article by Harry Adelman in which a bar magnet was used to induce a stronger field in the ferrite loop antenna of the receiver. Number 26 of *DX News* reported some subsequent difficulty in the receiver's sensitivity.

It is evident that the permanent magnet used to enhance the field around the ferrite antenna has introduced a significant amount of permanent magnetism in the ferrite core reducing its permeability and accounting for the lack of sensitivity. Ferrite core antennae rely on high permeability for proper operation. Since they are relatively small compared with air-core loops they have to 'grab' as much rf field as possible by presenting a path of low reluctance for the magnetic field. Permeability is the ratio of the flux density or magnetic lines of force within the ferrite core (B) to the magnetizing field or radio wave (H). Unfortunately, permeability is not constant, but decreases with the flux in the core.

When the large permanent magnet was brought close to the ferrite core, a magnetic circuit was set up consisting of the permanent magnet and the ferrite core. The flux density through the core increased dramatically. Since the permanent magnet also responded to the radio wave, this field passed through the ferrite core and resulted in a greatly increased signal level. When the permanent magnet was removed, many of the magnetic molecules in the ferrite core remained aligned with the field of the permanent magnet, and a permanent magnet was created in the ferrite having its own significantly high flux density. The permeability of the ferrite is now quite low, and it would take a large increase in the magnetizing force to make a slight increase in flux density.

The ferrite core, once magnetized in this way, would have to undergo a process whereby its flux density is reduced near zero, a process called 'deperming'. This is a lengthy, complex procedure, probably beyond the resources of most experimenters. It involves the magnetized material being wrapped uniformly along its length with a coil of wire. The existing coil probably won't do, as it most likely is concentrated toward one end of the ferrite core. The coil is then energized with a direct current further magnetizing the ferrite. The polarity of the coil is reversed, and a slightly lower current is applied. This reverses the magnetic field of the ferrite, but some molecules remain oriented in the original direction. The current is again reversed in the original direction, and a lower current applied. This process is continued until the current in the coil is practically zero. Each time some of the molecules remain in the direction of the last current application or 'shot'. The phenomenon is referred to as magnetic hysteresis. The process must be carefully controlled. The initial level of magnetization should be measured to determine how much current is required to start. The amount of current and the number of turns on the deperming coil determine the magnetizing force being exerted on the core. The final state of the core should then be measured to ensure all permanent magnetism has been removed. In the final state, half of the molecules are oriented in one direction, and half in the opposite direction. This results in a net field of zero. Permeability is once again at its highest level.

As you can see, deperming requires some reasonably sophisticated equipment to measure magnetic fields and control currents. Nevertheless, once a piece of ferrite has been magnetized, you have nothing to lose, and it may be worth experimenting to see if the total field can be reduced.

by simply doing nothing. The ability of a piece of magnetic material to retain permanent magnetism is its retentivity. This is greater in metals selected for permanent magnetism. Some materials lose nearly all of their permanent magnetism as soon as the external field is removed. In addition, the ferrite will be influenced by the earth's field and any other magnetic substance around it. It is even possible that it could be demagnetized by the same magnet which produced the original magnetization. This is accomplished by alternately bringing the permanent magnet closer to and further away from the ferrite core. Each time the direction of the permanent magnet should be reversed, and the magnet should stop a little farther away.

If all else fails, the ferrite antenna will have to be replaced. It is important when replacing this type of antenna that the secondary winding have the same inductance on both the old and new antennas. Otherwise, the RF or mixer stage of the receiver will not track properly with the remaining sections of the receiver. Inductance takes into account number of turns, coil diameter, and permeability.

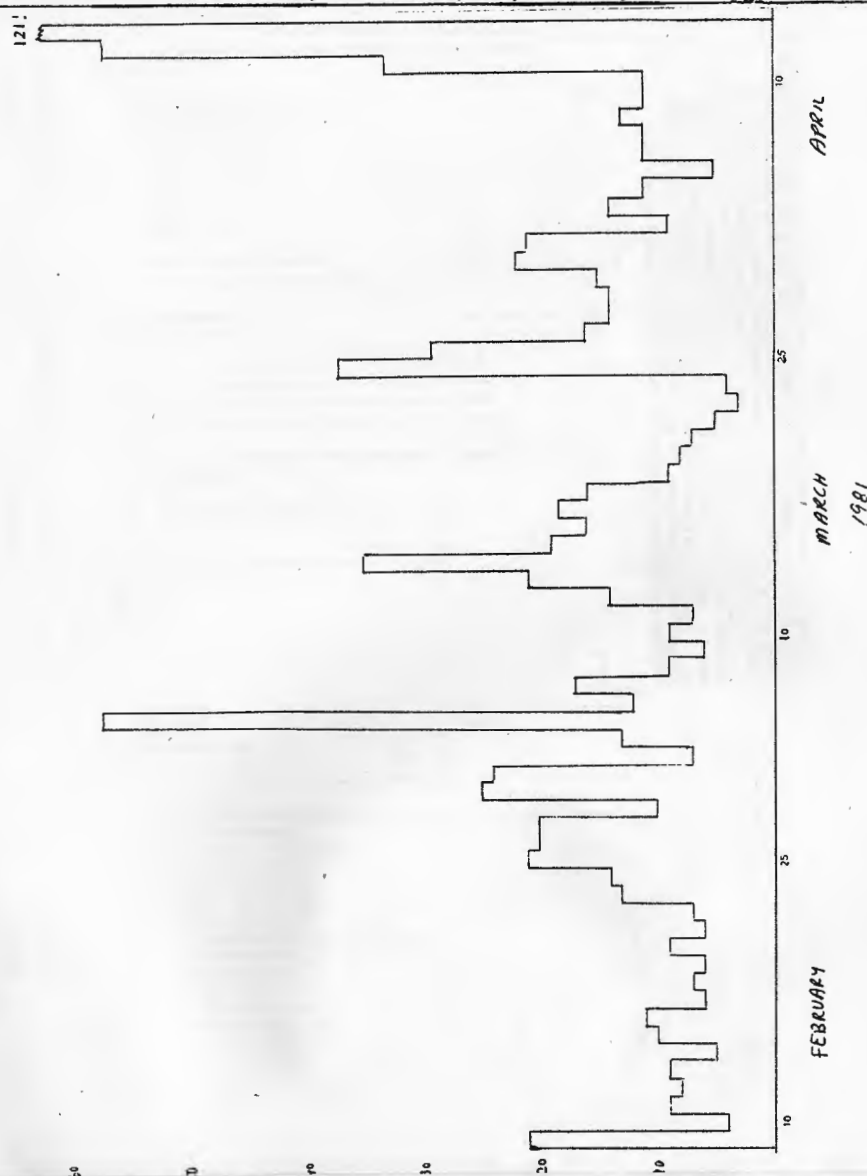

This graph shows the daily variations in A_{ff} , the Fredericksburg (VA) index of geomagnetic activity in the earth's magnetic field. High values (above 20) indicate that medium wave signals in upper latitude paths will likely be absorbed, thus resulting in "auroral conditions", with signals from the South and from local stations predominating due to this absorption of the more northerly signals. Low values over a period of time indicate a likelihood of more receptions on the higher-latitude paths -- more, and more northerly TA's and TP's. Several days of low values following higher ones are needed for conditions to return to "normal", due to residual absorption. Long periods of extremely low values (6 or less) are necessary to raise the possibility of good high-latitude conditions throughout the entire MW band, although this is not the only requirement. For additional information on the use of the A_{ff} and related indices as a DX tool, consult the NRC Reprints List for relevant articles. --RJE

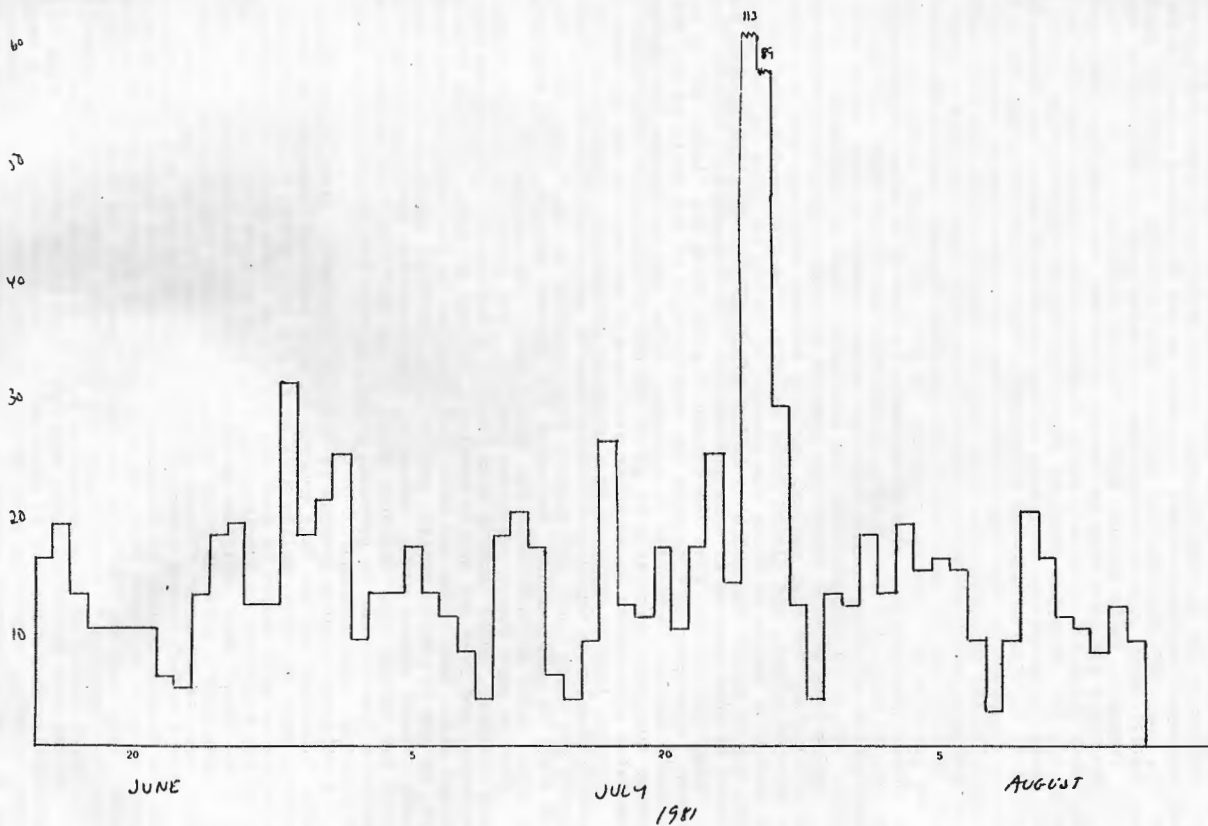
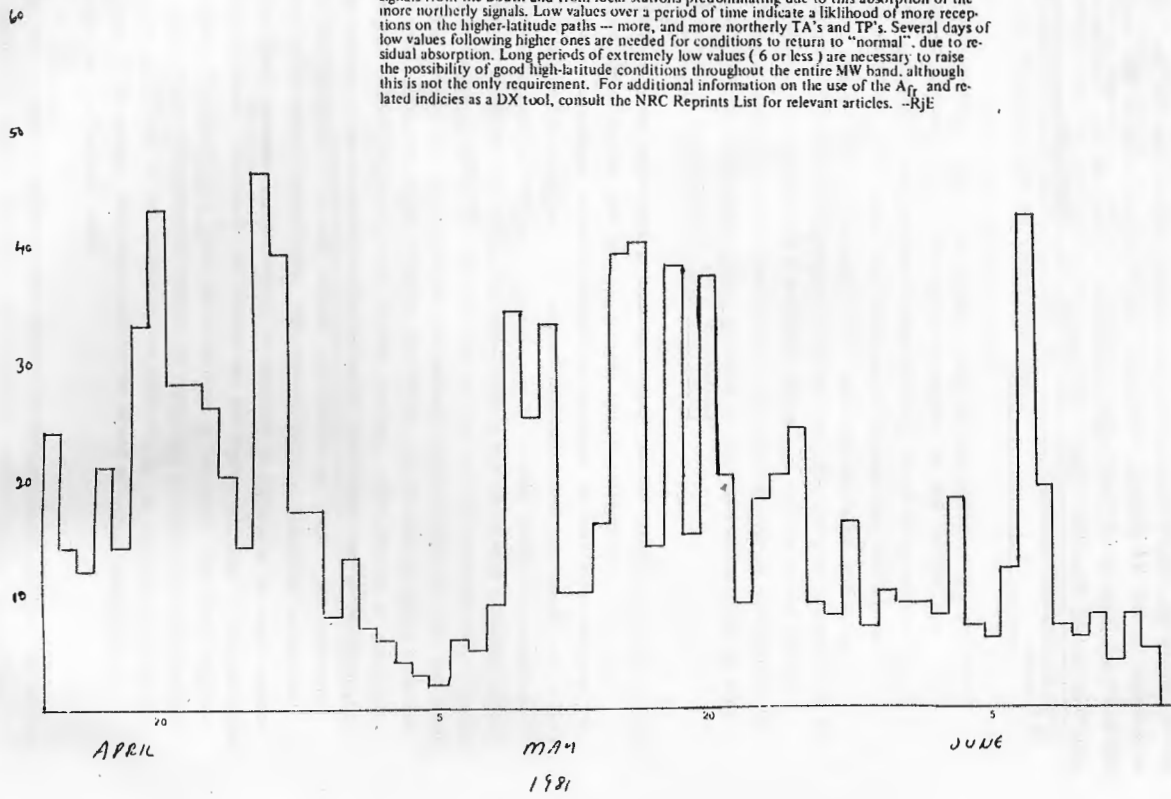

KCAM - STATION PROFILE

BY TONY FITZHERBERT

On the cold arctic night of Good Friday, March 27, 1964, the frozen tundra was traumatized from the blow of the great earthquake, and its handful of isolated homesteaders thirsted for news of the magnitude of this disaster. In a tiny wooden building in the darkened hamlet of Glenellan, a patch of civilization on the Alaskan Highway, several voluntary technicians and other staff members feverishly worked to get an as yet unlicensed radio station on the air. As these missionaries labored, armed with an emergency FCC permit, they finally could push a few buttons, and the signal crackled across the silent expanse. Radio station KCAM - 790 was on the air.

Few radio stations have as unusual a history, or dramatic birth as does the Copper River Valley's only radio station. This history began in the spring of 1937, when the Reverend Vincent J. Joy and his wife and infant son left their Collingswood, N.J. home to begin a mission among the Athabaskan Indians in the central Alaskan wilderness. That summer Vince and his brother built a log cabin in the tiny Indian village of Copper Center, about 180 miles northeast of Anchorage. Over the next few years missions were built in a number of other villages. Vince, foreseeing that the Glenn Highway would be built to tie Anchorage to the Alaskan Highway, secured two homesteads at the junction of these two roads--at the site that would become Glenellan. The mission headquarters were moved here, the hub of an area geographically the size of Ohio, but with a total population in 1960 of 1800 natives, homesteaders and others. For this vast area, a radio station would be a logical way to communicate with the scattered, isolated residents.

Radio Station KCAM shares the grounds of Central Alaskan Missions with Faith Hospital, the only medical facility between Anchorage and Fairbanks, the mission church, and Alaska Bible College. The station was inspired by the mission's desire to bring the message of Christ to folks in the Alaskan bush, and to assist the believer in Christian growth. The FCC granted the license to KCAM because of this philosophy. The transmitter, control board, and tower were trucked over the Alaskan Highway from the "lower 48" by volunteers. Missionaries completed the construction of the facility in 1964 and the staff awaited permission to operate. After the earthquake the station was granted emergency permission to go on the air to communicate with those in the devastated area--served by no other station--and has been on the air ever since.

Central Alaskan Missions is a uniquely independent organization with no denominational ties whatsoever. More than 80 people affiliated with the mission all raise their own support from churches in the "lower 48". The total KCAM staff is missionaries, including the General Manager, Chief Engineer, and other radio professionals who donate their time and talent.

KCAM is more than a religious station. The format is divided evenly among religion, music ranging from country & western to conservative contemporary, and news and public service. Through AP Audio and wire from Anchorage major news items and even live speeches by the president are broadcast, as are the World Series, professional football games, and other sports events. Local school menus, community announcements, advisements regarding school bus routes, and "Bulletin Board of the Air"--on which anything from available free kittens to personal items for sale are offered--supplement the national news coverage.

A uniquely Alaskan program is "Caribou Clatter". Aired three times daily, listeners may use this program to send personal messages to their friends, such as, "Aunt Mollie will be on the mail plane to Old Crow next Thursday, so tell Reuben to meet the plane", or "Jane Smith had triplets, and all of you relatives in Hurricane will be glad to know that mother and babies are doing fine!" Many religious programs round out the broadcast day, including "Unshackled", aired in prime time, and the most popular show on KCAM. Others are: "Nightwatch", "Chapel of the Air", and "Through the Bible".

KCAM's signal covers substantial portions of Alaska, and is audible well down the Alaskan Highway in the Yukon Territory. This writer DXed KCAM regularly at night at North Pole, 22 miles down the Alaskan Highway from Fairbanks. They IDed as, "Bringing you music, news, and the Good News, this is KCAM-790, Glenellan." Technically, the 5000 watt non-directional signal has an 0.5 Mv/M radius of 27 miles and an 0.25 Mv/M radius of 97 miles.

Unlike many Christian radio stations, KCAM sells commercial time to area businesses. They broadcast 18 hours daily. Programs originate in a small wooden building, consisting of a studio, control room, and office space. Most of KCAM's financial support is from its listeners. This building also houses "Herma", a computerized digi-card device which allows ten continuous hours of automated programming. Herma was purchased through donations from listeners and churches in the United States.

A KCAM project in conjunction with the Alaska Bible College is the formation of a Broadcasting department. Also, KCAM is devising methods of strengthening its signal in the Tok and Valdez areas.

Currently, the mission, now a division of Far Eastern Gospel, is constructing Radio Southeast Alaska to serve the Juneau area and much of the peninsula bordering Canada. A site has been acquired, a building for the staff erected, and a construction permit from the FCC is sought to build the tower and transmitter/studio facility. Like KCAM, this station will carry the Gospel, a variety of music, plane and ferry schedules, and weather reports in this roadless area, plus Caribou Clatter, and news and sports programs. Over \$300,000 is necessary to build the station. KCAM's staff is supplying technical guidance and support for the mission's new station.

Today, while KCAM serves the Copper River Valley, it is the only station between the Fairbanks area and Anchorage. It is a welcome companion for the lonely drive, as well as for homesteaders and trappers locked in the warmth of their cabins in the chilly, black, silent winter. From its dramatic beginning in the wake of the 1964 earthquake, KCAM has come to fulfill both the need to serve God, and to communicate with people who have either grown up in this beautiful virgin wilderness area, or fled the "lower 48" to lead a new, hardy yet simplified life...and is a tribute to many diligent, devoted people who give freely of their time and talents to serve.

NOTE: The writer is deeply grateful to Howard Gilbert, recently retired Director of Commuter Communications at Conrail, with whom he worked, for his help and guidance in writing this article. Howard and his wife have both served as missionaries for Central Alaskan Missions.

PUBLISHING SCHEDULE

DX News Publishing Schedule for Volume 49

Issue	Masthead Date	Pub Session Date	(Contributions to columns must be received 1 week earlier than this date by column editors)
1	October 12	October 4	
2	October 19	October 11	
3	October 26	October 18	
4	November 2	October 25	
5	November 9	November 1	
6	November 16	November 8	
7	November 23	November 15	
8	November 30	November 22	
9	December 7	November 29	
10	December 14	December 6	
11	December 21	December 13	
12	January 4	December 27	
13	January 11	January 3	
14	January 18	January 10	
15	January 25	January 17	
16	February 1	January 24	
17	February 8	January 31	
18	February 15	February 7	
19	February 22	February 14	
20	March 1	February 21	
21	March 8	February 28	
22	March 15	March 7	
23	March 22	March 14	
24	April 5	March 28	
25	April 19	April 11	
26	May 10	May 2	
27	June 14	June 6	
28	July 19	July 11	
29	August 16	August 8	
30	September 20	September 12	

SOME THOUGHTS ON INTERFERENCE

by Skip Arey

A while back one of our members contacted me concerning a problem with dimmer-switch interference. At that time I did not have any notions about the problem. But in talking with some fellow radio hobbyists I learned a bit more about the problem and its cure. If you have encountered any dimmer or thermostatic switch interference these mods might just do the trick.

First, go to your local radio parts store and acquire a vast quantity of .001 mfd. disc capacitors whose value is better than 250 volts. The more of these little bugaboos you buy the more uses you will probably find for them so get plenty.

The drawing in Fig. 1 shows how to attack an offending dimmer switch with two of these little gems. Please note that I have only tried this technique on SCR type dimmers, but then, that appears to be the most offending type.

The drawing in Fig 2. shows how a handy dandy .001 mfd. disc capacitor can be used to put an end to the noise that comes from any switching device such as an aquarium heater element, toaster oven, or (horror of horrors) those winky blinky Christmas tree lights that every radio freak's spouse seems to love so well.

Personally these methods have worked quite well, however!!!!
SAFETY NOTE***** Before trying these modifications be absolutely sure you are not violating any local electrical codes. Failure to check this out could void your fire insurance, etc.. You might need to secure the help of a licensed electrician to keep everything legal. **ALSO******* When bypassing anything, be very careful, work cautiously and be extra sure that you do not short out the line current or worse yet, wire things up in such a manner that the case or switch handle becomes electrically active. We do not want you to fry the fish in your aquarium, or you either for that matter. **BE CAREFUL. HOUSE WIRING CAN KILL!!!!**

MURPHY STRIKES**** These handy dandy mods work just fine and should give many hours of interference free listening. **WANNA BET!!!!** My wife just went out and bought herself a new fangled microwave oven. Talk about your basic QRM. Oh well, back to the drawing board.

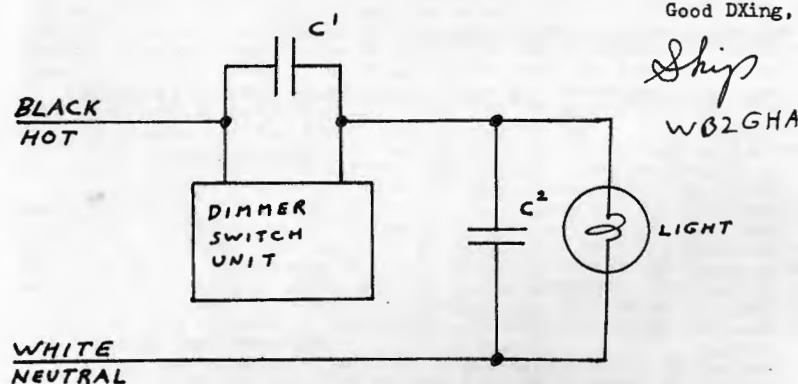

FIG. 1

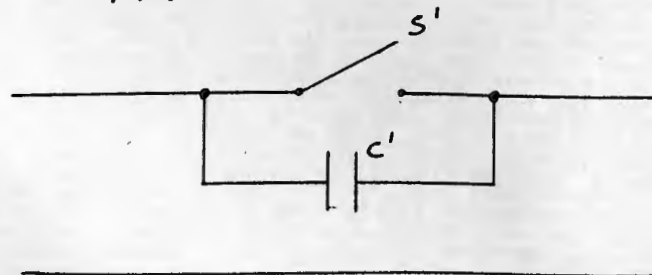

FIG 2

Good DXing,

Skip
 WB2GHA

MUSINGS

ERNIE COOPER
 5 ANTHONY STREET
 PROVINCETOWN, MA 02657

The opinions expressed in this column are those of the individual members, and do not necessarily reflect those of the editors, publishers or NRC.

MORRIS WAS AT THE ANARC CONVENTION

MORRIS SORENSEN - 53 Duncan Avenue - Kirkland Lake, ON - P2N 1X9 August 23, '81
 Here is a report from Kirkland Lake where I've spent most of my Summer. In mid-July I attended the ANARC convention in Thunder Bay, Ont. Most of the activity was SWBC-oriented which didn't bother me as I also have some interest in that aspect of the radio hobby. Of particular interest to BCB DXers was a talk by Lorne Saxburg of CBQ Radio, Thunder Bay, concerning the history and development of CBC broadcasting in general and CBQ in particular. He said that the CBC plans to give up many of its MW frequencies and move most of its transmitters onto the FM band within the next few years. I enjoyed meeting several NRCers at the convention, including GEORGE SHEEMAN, SHELDON HARVEY & BILL TOWNSHEND. It was also good to see most of the gang from UMDX in attendance and to meet or renew acquaintances with other DXers. Belgian Radio Television phoned during the convention auction and carried a live interview over their EE transmission to North America. After the convention I returned to Kirkland Lake via the south shore of Lake Superior with stops in Duluth, Marquette, and the picturesque village of Gaand Marais, Mich. During my travels I noted that CFFA-1230 Thunder Bay is now CJRB and that WIDG-940 St. Ignace Mich. is back on. My only addition to the Kirkland Lake log this Summer was on 7/5 when I pulled in CFOS-560 Owen Sound, Ont. on the TRF @ 9:30am w/local CJKL off due to a temporary power interruption. On 8/16 I heard unnn R. Paradise-825 in well @ 9:58pm, so CX must be improving. 73.

PETER HAS MOVED TO BRITISH COLUMBIA

PETER A. NOLAN - 861 East 14th Avenue - Vancouver, BC - V5T 2N5 604-873-6356
 Greetings to all, just in time for another MW DX season. The new address and phone above have been part of a long and well-travelled Summer that saw a three-week trip to the Southwest, Florida, & the Chicago GTG & back to Arizona & Mexico after moving from Eugene to Seattle in June; quitting my Summer job in Seattle after a week and spending the next few commuting between there, a future home in Vancouver, and my fiancée, still living in Eugene; we finally moved up here in late July. Still to come in the next month: 2½ weeks in Korea & Japan and a possible week in the Canadian Rockies and Far-Northern B.C. It'll be nice to settle down. I haven't had time for much more than bandscans of the local dial here yet, but there are enough locals and noise to make me appreciate places like NE Arizona, the Oregon coast, or Northern BC, where there ARE no locals. A brief FM opening was the only thing of interest. My final tally in Eugene was 720 heard over most of five years (with about a year in other locales). No idea how many verified as during that time I gradually gave up counting and finally gave up verifying altogether except for special occasions; it's too difficult to keep a coherent collection when one changes locales so often. A brief re-intro: This December will be my tenth anniversary of getting into DX, without, at the time, knowing of clubs or of anyone else doing the same thing. (Early prize catches, according to the logs of my early teens, included WHAN-1200 Rochester NY; KRNT-750 Tulsa, OK; & the like. Eventually I did get a log book and correct my mistakes!) Over the years I had about 1600 heard from Midwest locations in KS, MI, & IL, & the above Oregon totals. In the last four years I've also gotten heavily into collecting sales & promotional materials (stickers, CMs, buttons, T-Shirts, etc.) from stations, an outgrowth of all the coverage maps I kept getting with veries. I'm now up to material from about 5,000 stations, and more is always welcome. (I also have lots of duplicates for trade). I'm now in BC teaching East Asian Regional Studies & Political Science at the U. of British Columbia. Hopefully, by next time I'll have recovered enough from all the travel to do & report some DX.73.

ALL'S QUIET ON THE NORTHERN FRONT

BRIAN VERNON - General Delivery - Elsa, YT June 23, '81
 The clip about CFCT-600 carrying R. Moscow programs was interesting, but they never did in fact carry any. They are now being funded by an "un-named" Canadian source, although CFCT is listed with 1,000w, it's only using 250 "to save tube life". I noticed CFFB-1210 has applied for a power increase to 1,000w & frequency change to 1230 kHz, so better get it while you can. Not much DX gets through here this time of year. CKDA-1220 puts in quite a good signal at twilight. All for now. 73's.

THE NEWS IS OUT! NRC'S NEXT CONVENTION SITE IS - L O U I S V I L L E ! WE'VE BEEN THERE BEFORE; LET'S BE THERE AGAIN FOR BIG DOINGS SOME 11 MONTHS HENCE! THEN WILL COME OUR GIGANTIC 50th ANNIVERSARY CONVENTION - IN HARTFORD, CONN.!

KERMIT HAD A VACATION IN NEWFOUNDLAND

KERMIT GEARY - R. D. 4 - Box 321 - Walnutport, PA - 18088 August 31, 1981
 : : : : : VOAR-1230 (100w) and VOWR-800 blasting in? Yes, if you cruise the streets of St. John's, Nfld. with the car radio on! These, along with practically every other Newfie station, were heard while on a trip there during the latter half of July. A novel experience, but of no help to my log which is holding at nine from that province. A plaque in front of the Wesleyan Church studio of VOWR tells the history of Newfoundland's first broadcasting station. Starting as 8WMC, w/100w, in July 1924, it became VOWR in 1932. On Signal Hill at the entrance to St. John's harbor is a plaque commemorating the reception of the first TA signal by Marconi at that spot on Dec. 12, 1901. Travelling and outdoor activities took their toll of my time during the Summer, with the result that very little listening was accomplished. The only recent loggings have been the following: 8/17- WADJ-1330 8-8:15pm s/off. 8/18- WLLM-1580 6am s/on-6:15, & WADJ-1330 as before. 8/20- WYRD-1540 6:15 s/on to 6:24am, w/CHIM QRM. 8/31- WYRD-1540 again from 8:05-8:15pm s/off. Noted in passing: WNPA-1340 now IDs as "Twin-W Radio"; WADJ-1330 is "13-DJ" and programs American Top-40 mx & Mutual MX. The following veries have been received since my last Musings: WPCN-960 (1 on CM), WETT-1260 (v/l-CM/promo; thanks, DAVE GLEASON), WRLV-1140 v/l, WPKX-730 v/l-CM, WRR0-1440 (v/l-CM), WPOE-1520 (v/l), WSBY-960 (v/d), WLLM-1580 v/l, WADJ-1330 (v/l-rate folder), TIRN-575 (v/l-sticker-photo card); Caribbean Beacon-1610 v/l & VOA-1580 Antigua (v/q). The letter from the Caribbean Beacon confirms my logging of their announcement of a power of 15,000w, saying: "The Government does not have enough generating power for us to go to 50 kilowatts" (as of May 2nd). WADJ-1330 is directional, nulling toward the W to protect WCVI-1340, and said that mine was their first DX report. On to September and better DX CX! Good DX to all!

JIM IS NOW AT WOMP-1290

JIM WALLACE - 63280 Sand Hill Road - Bellaire, OH - 43906 September 4, 1981
 : : : : : It's been a long time since you've heard from me, so here is an update on what I've been up to. Since Sept. 1980, I have been a reporter and morning news anchor for WOMP Radio in Bellaire. It's a news/talk station affiliated with CBS. I'm in charge of the three-hour NX block beginning at 6am each morning. My wife, Sandy, is a reporter for the Times Leader in Martins Ferry. We've both been kept busy during the past year and that's why you haven't heard from me since we moved out of Columbus. We are living in a two-story house on top of a hill seven miles outside of town. It's a wonderful location for DXing. In my first AM DXing season here, I logged 507 stations from 34 states plus DC, three provinces and ten countries. I think that's a good start. I logged 1,168 stations from Columbus and 1,017 from the Cleveland area. As a result, I did not do as much DXing on the AM & FM bands as I just finished my first TV DX season. I always had cable service in Columbus, so I never had a chance to DX off the TV. This Summer, I logged 73 TV stations from 18 states, plus Nova Scotia and Cuba. As a result, I did not do as much DXing on the AM & FM bands as I have in past Summers. I was fortunate to obtain a verification of WSRD (FM) from JERRY STARR. Thanks, Jerry. He asked me in his letter when WOMP would have a DX TEST. Well, we have a new CE who is doing a lot of good things. I hope to talk him into a TEST. If anyone wants a verification of WOMP, send your report to me. WOMP broadcasts from 6am to 6pm with 1,000w ND (500w PSA). Have a good DX season. (Many years ago during our Wheeling NRC Convention, I & several other NRCers broadcast a 15-minute panel discussion of DX on WOMP! -ERC)

SIDNEY'S NEARING THE ONE-THOUSAND MILESTONE

SIDNEY E. MARSHALL - 7224 Pam Drive - Millington, TN - 38053 Sept. 4, 1981
 : : : : : By the time this Muse is in print the 1981 NRC Convention will be history. Due to health reasons, conventions and get-togethers are out for me. My friend NEAL PERDUE, in a recent letter, tells me of a regional SEUS AM DXers' GTG in late September he will be attending which is also out for me. The past couple of weeks have been very good for DXing which maybe is an indication that we are in for a "super" upcoming season! In fact the static level this Summer has been much lower at my location than it was last year. I've logged 11 new ones since my last Muse which brings my station total to 955 heard. These "newies" are as follows: On the evening of 8/9, only a few hours after mailing my last Muse, KOKE-1370, TX, was in @ 8:59pm for a couple of minutes w/ end of Texas State NX, top-of-hour ID, & into mx. A few minutes later at 9:12 pm WABD-1370, KY, was in w/a spot for a business in nearby Hopkinsville, then mx & full s/off heard @ 9:15pm. Somebody slipped up for this is a late s/off for daytimers in this area! Then on the AM of 8/15 WEAG-1470 TN was in @ 6:29am u/ KLCL, w/ID, TC, & mx. On MM 8/17, not being able to sleep, I switched on the ol' RF-2200 and KENR-1070 TX was in several times from 3:54 to 4:07am. Later the same morning, I caught the s/on of WVOH-920 GA, @ 6am. More SRS DXing on 8/23 reaped me much wanted WNOO-1260, TN, in with excellent signal from 7:25 to 7:30am. Then on 8/24 @ 9:29pm I caught the full s/off of KSIB-1520, Iowa, u/ KOMA. On morning of 9/1 between 6 & 6:01am I heard the s/on of WODY-900, VA, & WKJK-900, NC. On 9/3 @ 6am WTLK-1570, NC, boomed in w/s/on heard. Then on 9/4 @ 6:59am WMGR-930, GA popped in w/ID & spot with mention of Bainbridge and into NX. That's it for now, so good DXing to all! (What & Where is a "SEUS" DX GTG?? -ERC)

WELCOME BACK, DARIO!

DARIO MONPERINI - Via Davanzati 8 - 20158 Milano, Italy 30 August 1981
 : : : : : Hi to everyone in the NRC Family. I am again a member after one year absence, I presume still the one member from Italy??? I re-introduce myself: 31 years old and ten years spent in the DXing life, actually I utilize Grundig Satellit 3000 and a home-made loop antenna. My first interest is still to DX AM band even if the Auroral CX here in South Europe haven't offered so much new thrills; usuals Upper Volta-747, Gabon-1555 & Senegal-765 (the latter now crawled by a new Morocco Arab station). In Italy we are really interfered by the new Algerian stations, 10kw are sufficient to stop nice channels for example, 1100 kHz crashed by 1098 new Algerian. Reception of USA ended almost in my area in early June with WEGP-1390 & WITS-1510. Mid-August opening was not found this year, only riders & storms. Let me hope for a better TA future. I ask to everyone in our Club to express his opinion about the present solar cycle, I guess it is 22 years cycle, but if the best period has been in 1974-1976?? Next will be in 1996-1998?? Hi! Thanks to all the ones who will Muse about this question in next issues. One item which may be interesting for TA fans over 882 kHz now operates EAJ-20, R. Sabadell, Spain (ex-1602 kHz) at 00,00 AM - 9,00 PM except Saturday they s/off 7pm. The station carries "Carretera" Sunday till Friday at 7-9pm. Now over 1602 kHz the dominant Spanish is R. Vitoria, EAJ-62 s/off every day at 7,00pm with local ID after "Medianoche Ser". Look at Spanish all-nighter service chain, R. Ser, Madrid-810 repeated over 873 kHz Zaragoza, 1026 Vigo, 1080 Granada & also 1485, 1584 & 1602. If you have European problems, Muse or report in the CHUCK HUTTON column & I or other Europeans will do our best to solve your UNIDs. I will Muse soon after the first TA NA opening...hoping before Christmas 1994! Hi. 73's to all.

AND WELCOME BACK, ANTHONY!

ANTHONY LAGATTUTA - Box 6291 - Portsmouth, VA - 23703-0291
 : : : : : Greetings. July was special as I enjoyed a fine week of vacation with ERNIE COOPER in Provincetown. Upon returning to VA, I had the privilege of meeting fellow NRCers MICHAEL DEITZ and BRADLEY WILKINSON. Of interest to FM DXers is that local WKEZ-95.7 is now WLTJ and IDs as Y-96. C&W local WPEX-1490 IDs as "X-15". WLTJ (FM) is more MoR rather than EZL as was WKEZ. Recently, I made a few changes in the home-brew LW receiver and it now receives the top end of the BCB (1510 to above 1750), using a 9" ferrite rod antenna from J. A. WORCESTER. Some interesting DXing daytime (around high noon, etc.) was recently done from the Northern part of Suffolk, VA, & Fort Story in Virginia Beach. With local WVAB-1550 still off the air it was interesting to find that WADK-1540 puts in a good signal far inland from the beach, even into Suffolk! WPRO-630 used to do well but WADK is so much higher in frequency. Also, the new WSBV-1560 was IDed in the daytime, thanks to help from ERNIE COOPER. WG0E-1590 IDs as "AM-16-GO". WLLM-1580 (easy listening) is like a local in VA. Beach, along with WIBG-1520, stronger than near-by WEXM-1520. By the way, WVAB-1550 still has their XR & tower in the middle of Bow Creek Golf Course. WQXR-1560 could be IDed faintly in the daytime with WQXR-1560 nulled. WQXR was using their FM ID "X-104" and "Extra-104", evidently the two outlets are running parallel. WETT-1590 IDed as "16-WETT". This seems popular on AM now as on FM, hi! Most interesting of the daytime signals seemed to be W.VA. heard at Fort Story with WXVA-1550, Charles Town, though they are often very strong close to sunset. WADK-1540 on SMs plays old time radio programs like "The Shadow", etc. WADK-1540 has frequent IDs & so does W0BR-1530 which is nice for the DXer. Does anyone DX the unusually-sounding signals above the BCB such as around 1650 kHz? These are probably navigation signals such as raydist which a few years ago had a company based in Hampton, VA. I would enjoy writing to DXers who enjoy building and experimenting with their own receivers, especially portable types. Best wishes.

JEFF HAS SOME NEW DX TOYS

JEFF FALCONER - Box 63 - Clinton, ON - NOM 1L0 August 26, 1981
 : : : : : Hello everyone. Now that the Canadian postal strike is finally over I can send in a Muse. The big news here is that I'm now DXing with all new gear. I'm using a new JRC NRD-515 receiver with memory unit and I'm very pleased with it. It easily runs circles around any other RX I've owned including the Collins 51J-4. It was purchased from Gilfer and they installed optional 3 kHz & .6 kHz filters at no extra cost. Also new here is a Realistic CTR-51 cassette recorder, Realistic Pro 30 phones, Autek QP-1A audio filter, and a new 190" LW. The trusty old TRF and SM-2 round out the equipment here. So I should be good and ready for the upcoming DX season. For those of you who send IRCs with your reports to foreign countries, prepare yourself for a shock. Two weeks ago IRCs were 45% each and today (8/26) they are 87% each. Boy, talk about inflation! A bit of DX has made its way into the earphones despite a hectic work and social schedule. I've also been spending a lot of time on the ham bands (call it VEJLSK, look for me on 40 or 20 CW). My recent DX has been sent into CHUCK HUTTON & DAVE SCHMIDT, so you can read about it there. A few notes of interest: WKTQ-1320 is IDing as WJAS (remember when it was WJAS about ten years ago?) w/MXL format. Also WCHB-1440 is IDing as "More power to the People" so likely their CP for 1,000w night is on. Has a nice signal here at night. I plan to be more active this season, so 73 and I'll CUL.

CARL'S VERIFIED SOME CALL CHANGES & F/UPS

CARL W. DABELSTEIN - 8209 West 78 Street - Overland Park, KS - 66204
Not too much time has been spent at the BCB dials here this Summer - primarily limited to logging call changes. KKOW (ex-KOAM)-860, Pittsburg, KS, heard w/c/w on 6/7, a daytime regular here. On 6/14 I got KEWI (ex-KGMO)-1550, Cape Girardeau, MO, also w/c/w @ 8:25pm. 7/22 brought an ET with intermittent TT from WUCR-860, Sparta, TN @ 2:20. KWLO (ex-KWWL)-1330, Waterloo, IA with AN Request Line @ 2am on 8/9. Semi-local KGNM (ex-KUSN)-1270 in St. Joseph, MO heard for first time with new call on 8/19. Format is GOS with regular commercial spots. Finally, 8/23 brought KBRQ (ex-KTLK)-1280 in Denver running c/w. A few veries were received this Summer, mainly as a result of f/ups: v/l's from KGAS-1590, KTLO-1240, KWLO-2330, v/q from WHPB-1060, v/f from WPIC-790 & v/r from KQXR (ex-KSPR)-1590. Total veries is now at 2,093. I had a chance to visit KTAR in Phoenix early in the Summer when I was in town a few days to testify before the Arizona Corporation Commission in some utility rate cases. I also noticed a Travelers Information low-powered station just off the edge of the BCB giving parking info for the airport. This got out quite well as I heard it throughout the city. On 8/17 I had a chance to visit with fellow NRCers NEIL ZANK & BOB MCCOY in Lincoln while I spent a few days in the old home town. Not too much else for now, so 73's & I hope everyone has good luck during the upcoming season.

TRUAX TRULY ENJOYED THE CONVENTION

DICK TRUAX - 3003 Gleason Lane - Louisville, KY - 40299
Greetings once again from the Bluegrass State and also the site for the 1982 NRC Convention on Labor Day weekend. Looks like Gary & I are in for a repeat of 1976 - hopefully 1982 will outdo the 1976 shindig. More details later. After attending the 1981 Convention in Rockaway hosted by RUSS EDMUNDS, we'll have a lot to do in order to better his program. True, there were no station tours, contests, etc., but I found myself busy every minute visiting with so many members who previously were only names to me. And Russ had a great idea in setting the theme of nostalgia all throughout the meeting, including great memories outlined by ERNIE COOPER, HARLEY STEWARD, PETE CLARIUS, CARLETON LORD and former publisher DICK COOPER. I can say that 1981 was truly one of the most memorable Conventions of the seven or eight I've attended; I think those in attendance will also agree. And as always, a convention always serves to stimulate my enthusiasm for DXing after a long noisy Summer away from the hobby. Down to BX; only two to report since last Muse. 8/1- WSWV-1570 VA on way past legal s/off time with FM programming and many ID's @ 8:55pm, off abruptly at 9pm. 8/28- New WUIV-1580 NC w/SID and many mentions of merchants in Morganton and Hickory @ 7:55am. This one is super-easy to log as it is off frequency and creates a nice het. S/on in September is 7:15am, so this may help someone yet this month. It kills semi-local WAXU until fadeout every morning after 8am. I still have a mint PRG-7 w/R. West added 2.1 kHz mechanical filter and digital readout if anyone is needing a receiver for the upcoming season. More ss it happens.

THE STRIKE IS OVER; THE VERIES TRICKLE IN

DAVE CLARKE - 6 Liberty Street South - Bowmanville, ON - L1C 2N2
Another messy Muse from muddy Bowmanville...thanks to eight straight days of rain...has the sun gone to the Cape? (Nope; it didn't come this way, hi- ERC) I hope everyone is enjoying the Summer. Ours went well w/a good holiday on beautiful Manitoulin Island, Ont. (Northern Ontario). Not much DX lately, usually CX have been poor, with Aug. 25/26 being the only interesting nights, with semi-AU CX prevailing. DX as follows: 8/25- I logged WQA-1580 w/EZL mx, off @ 11:58pm. This left HJQZ-1580 atop, playing LA pops, M & F w/"R. Principe" IDs. 8/26, more good Latin CX, w/XEEF-1130 @ 10:30pm dominating frequency, no sign of WNEW. Many "R. Exitos" IDs were a mystery until checking PETER TAYLOR's excellent Baja Bandscan in March 23 DX NEWS. Aurural CX ended after 8/27, but not before logging long-sought R. Caymans on 1555 @ 10:10pm, M DJ in Caribbean EE playing U.S. Soul/T-40 mx. A nice surprise was when Cayman faded @ 10:54, with a sudden appearance by a man in SS giving "La Voz de Guabo" ID, reappeared again @ 11:04 for three minutes, then gone completely, first from Ecuador for me. Nothing else new till 8/30, when I caught WVKO-1580 OH signing off @ 8:30pm, no SSB. Then I tuned down to 1400 kc/s to find WREC-PA playing oldies, IDed as "The Sunday Night Hall of Fame in the Capitol City", on top past 9:30. Latest newie was on 9/2, with WMMN-920 WV heard carrying Pirates BB @ 2:11am - on late? Signed off @ 3 after end of game, following short local NX & SSB., thanks to SKIP AREY for Sports Network list. Totals are now at 458/303 - look out, Ernie! Not too many veries back, thanks to our 42-day mail strike, while our courageous Prime Minister was on holiday in Africa! Only three veries back, v/l from CKOB-1400 and WPDF-910, v/q from WFBG-1290. I hope the Convention was enjoyed by all, I'm looking forward to reading all the tales, hi! That's it for now, I hope the sun shines before this gets to print. Thanks to Louisville Duo, I received the July & August DX NEWS together in one envelope only a week after the end of the strike. Good work! 73's.
AS THEY SAY IN WHITEVILLE, NC, "WENC"-1220 -WE ENJOYED the NRC CONVENTION!"

CHRIS BAGGED A TRF 12-655 in ROCKAWAY

9/8/81

CHRIS HANSEN - 2825 Webb Avenue, 5F - The Bronx, New York - 10468 212-549-6613
I'm just back from the 1981 NRC Convention in beautiful Rockaway NJ. I would like to thank RUSS EDMUNDS for handling the conventioners single-handed; I'd also like to thank RON MUSCO for putting me in my place (hi!) JEFF WEINBRUM & I arrived in a Rockaway NJ police car (there were no taxis in Rockaway - which says something about the place) on Friday afternoon, and the fun started almost immediately. On Saturday, as SKIP AREY, STEVE PARADIES, JEFF & I were reconnoitering the area, Steve discovered a Radio Shack just down the road from the motel which still had a TRF 655 for sale. Unfortunately for Steve, he didn't have the requisite cash, & I bagged it for myself. Unfortunately for the other Convention attendees, the Radio Shack didn't have any more TRF 655's in stock. I am currently planning major modifications to the TRF. The banquet was sumptuous, and the nostalgia trips back into the thirties by some senior DXers present were very interesting. Since it was my first NRC Convention, I was pleasantly surprised that brew was almost continuously available in the meeting room. (Why do you think ERC goes to all the Conventions, Chris? -ERC) I bagged all the extra-large T-shirts at the auction (there were only two); and, of course spent more money than was wise. However, all present seemed to have a great time. I am planning to be at Rocket Bay's over Thanksgiving weekend, and am also planning to be at Louisville in 1982 & in Hartford in 1983 (Let no one say that the NRC doesn't plan ahead!!) On another subject, for a project for the NRC I am wondering whether there are any professional word processing people other than myself in the NRC. If there are word processors out there, I would appreciate it if you could call or write me. This goes double for any word processor who uses or has access to any Wang word processor. I am investigating this right now, and would appreciate your spare time, if any. Seventy-three's to everyone out there, & as soon as I start using my modified TRF, I'll report my DX, if any. 30.

THERE'S A NEW ONE ON 1190 in COBLESKILL, NY

GARY MITCHELL - Bridgeport, Connecticut Sept. 4, 1981
What a pain - 100% burn-out over breaking into BCB QSLing and logging menbe 200 stations and getting ignored by many-many. Now it's using my brains trying to get QSLs out of no replies until it drives me bankrupt. I'm sure I will figure out a technique eventually that will squeeze those QSLs out of them. Perhaps I will have to pose as a radio superstar and be so baffling they cannot ignore me. I got QSL back from WSTJ-1340 St. Johnsbury, VT, photocopy of old v/q. I got a QSL from WARM-590 Scranton on an old 2¢ postcard! I finally got WCKL-560 Catskill, NY verie from engineer who never got request before. I logged WSCR-1190 Cobleskill, NY who even ERC tells me does not exist. I might be crazy but they're broadcasting on 1190 from that area as WSCR. I heard "Radio Pirate New England" on 1620 supposedly broadcasting from some mountain in Mass. New ones heard, WBNC-1050 Conway, NH, WCNL-1010 Newport, NH, WASR-1420 Wolfboro, NH, WBTN-1370 VT again, no reply from first QSL request. WPLM-1390 Plymouth, MA (hard one for ERC!) WELV-1370 Ellenville, NY, WVOS-1240 Liberty, NY, WDLA-1270 Walton, NY, WDNH-1590 Honesdale, PA. I finally got Atlantic City's except 1450 because of local. I would have to go mobile 20 miles or so to get it (or less) but NRC frowns on mobile QSLs. Anyway AM BCB listening is for FUN, not to enter race for most heard/veried, etc. Something wrong with CX in August - no South heard except Spanish. Must be my location, ocean to South. QRM. Usually South comes pouring through at SSS s/off. Who knows. Maybe my mind is telling me (sub-conscious) I'm backlogged from my West-North, etc. and widdle away at those QSLs first! Yep - I heard a lot of FM in August from NJ, MD, DE, & even that Orleans, Mass. station. (WKZE-FM-104.7 -ERC).

A TELE-TIP NETWORK IS BEING FORMED

PAUL MOUNT - 471 Emerson Avenue - Teaneck, NJ - 07666 201-836-1137 9x9=81
I'm working at compiling a list of phone numbers for DX tip trading. If you can receive phone calls on Monday morning, please send me a card and tell me your phone number. Also indicate if you can receive calls Sunday morning or at sunset, if you DX those times. If you DX MW but can only make calls (if a ringing phone wakes the household) you would still be eligible to participate, as I plan to put this list in the bulletin for reference. I started getting information for this list at the NRC Convention but didn't get to speak to everyone about it. More about the Convention later. Meanwhile I'll say that I can be called at the number above on MMs only; I may get a number change (to my own phone) this Fall. 73 & buena DX - FRM.

STATEN ISLAND'S TEN WATTER IS ON THE FM AIR

BILL BERGADANO - 39 Marble Street - Staten Island, NY - 10314 (via phone)
Greetings! Latest news is WSIA-88.9 FM is on the air. So far they've gotten out as far as Connecticut (with 10w) - at least they say so. Otherness: I'm looking to get in touch with Utility Band DXers to help a budding novice in that part of the hobby. Other than that, not much DX on MW due to poor CX. I planned to be at the Convention but I got a call at 10:30pm the night before I was supposed to leave from Jack Kerman who said he had to back out. I had no way to get there so I canceled out. Wait till next year! Then again, I said that last year! 73s from Bill.

THOMAS WANTS TO TRADE PROMO ITEMS

THOMAS E. CONNATSER - Route 9 - Box 78 - Sevierville, TN - 37862 9/9/81
 Greetings, fellow dial-twisters. I hope you all had an enjoyable Summer. I would have liked to have made it to the Convention, but someone had to stay behind and give you some DX to catch! I look forward to reading the Convention reports and hope all of you had a good time at the Convention. Well, it's just about time to dust off the RX & get ready for another season. I'm sorry to hear that JOHN CALLERMAN is running into so many delays in preparing the new Domestic Log. I am anxiously awaiting the new edition. What is the current status on a day pattern book? I feel that this book would be very useful as many of us DX during the daylight hours. DAVE YOCIS, welcome aboard as Sports Network Editor. As an avid sports fan, I am looking forward to seeing his column. Speaking of sports, it appears that WRJZ-Knoxville will NOT be carrying Tennessee FB this season as I had earlier reported. WIVK-FM is the flagship station for the Vol network, and they seem to be the only Knoxville affiliate this year. WECO is also affiliated with the Vol network and will be carrying all day games. When the Vols play at night or have an open date WECO will pick up another game in the SEC. I'd like to help Dave compile a list of football nets, but working on Saturday afternoon, I don't have the time to tune around and see who is carrying what games! All of us at WECO are anxiously awaiting a construction permit to increase our power to 5,000w. The application was filed on June 1, but you know how long it takes the FCC to act on these matters. Locally, WKGN-1340 Knoxville has been sold and a format change is supposedly in the works. The station plans to go dTLK/nC&W. The change was to take place Aug. 17, but as of today (Sept. 9) they were still on the old format. I'll let you know when they finally make their move. Also WTNR-Kingston is expected to go from 500 D-1 to U-2 1,000/1,000 some time this month. Pattern will be toward the West per a newspaper report. This season, my goals are to add quite a number of veries to my collection, as I am now keeping a paper verie file, build up a collection of station promo items, add to my aircheck file, and of course hear as much DX as possible. Anyone interested in trading promo items and/or airchecks, please write. Until later, 73 & best of DX to everyone.

THE WAY THE BAND IS IN DE SOTO

BOB JINKERSON Jr. - Route 4 - Box 12 - De Soto, MO - 63020 1-314-586-8552
 Since I've only Mused once since rejoining NRC, I figure it's high time I let you know I'm still alive and well here in De Soto (about 40 miles S of St. Louis). I've decided to send along a daytime bandscan. I feel bandscans are interesting and useful, particularly to novice DXers. These are my regular daytime receipts at 12 noon EDT: 550-KSD-MO; 570-WKXX-KY; 580-WILL-IL; 590-WRTH-IL; 610-WDAF-MO; 630-KXOK-MO; 650-WSM-TN; 670-WMAQ-IL; 690-KSTL-MO; 720-WGN-IL; 730-KWRE-MO; 740-QVLN-IL; 779-WEW-MO; 780-WBBM-IL; 790-WRMS-IL; 800-KREI-MO; 810-KDMO-MO/WMTS-TN; 830-KBOA-MO; 850-KFUD-MO; 860-WSON-KY; 890-WLS-IL; 910-KLCN-AR; 920-WGNUM-IL; 930-KWOC-MO; 940-WMIX-IL; 950-KILK-MO; 960-KFVS-MO; 970-WMAY-IL; 980-KSGM-IL; 1010-KXEN-MO; 1050-KMIS-MO; 1060-WMCL-IL; 1120-KMOX-MO; 1140-KPWB-MO; 1190-KHAD-MO; 1220-KLPW-MO; 1230-WHCO-IL; 1240-KFMO-MO; 1260-WTBV-IL; 1280-KYRD-MO; 1300-WFRX-IL; 1320-KADI-MO; 1380-KWK-MO; 1400-KJCF-MO; 1430-WIL-MO; 1450-KFTW-MO; 1460-KIRL-MO; 1480-KPIA-MO; 1490-WESL-IL/KTRR-MO; 1510-WINU-IL; 1520-KMPL-MO; 1530-KPCR-MO; 1540-WSMI-IL; 1550-KGMO-MO; 1570-WOKZ-IL; 1580-WDQN-IL; 1590-QAIK-IL; 1600-KATZ-MO. These stations are regularly received at this location on my TRF. My totals are now at 444 heard, 34 states, nine countries. For those out of this area, KSD rarely IDs with its call letters, but with "55 Country". Also, WRTH-590 now uses announcers more frequently--most notably Paul Warner and Decatur Agnew (really!), KXOK-630 employs a nightly oldies format called "The Time Machine". 73s.

STEPHEN HAS WUIV'S ADDRESS FOR US

STEPHEN H. PONDER - Box 1712 - Matthews, NC - 28105 Aug. 22, 1981
 Hello again from Metrolina! Sorry for such a long delay in writing a Muse, but work has to come before fun, or is it fun has to come before work? Anyway, suffice it to say that, like Mark Twain, the reports of my demise are greatly exaggerated. One goodie to report to the Club as a whole - WUIV-1580 is on the air in Icard, NC, with 5,000w daytime non-directional. A hasty phone call to the station (704-397-5549) bagged me the mailing address and a few station details. CE is Dr. Charles Cooke, one of the announcers is Steve Beaver (he's the one I got on the phone) and the mailing address is P.O. Box "1" in Icard, NC, 28666. Steve said that they've been on the air since March 1981 and have gone from a BFL format in the beginning through POP and are now into Adult Contemporary, which is verified by listening to their programming. They do carry a few CBS Network items, such as CBS NX, Mike Wallace at Large, etc., but do not know if they carry Radio Mystery Theatre. They carry spots for such places as Morganton, Hickory, Textile, and Valdese, so I imagine by the size of Icard they are using out-of-town businesses to stay on the air. Anyway, take note of this newie and put it into your NRC Log. Interesting DX to note comes by way of WBCU-1460, Union, SC, and WFGN-1570, Gaffney, SC, all heard just a few minutes before WUIV-1580. Good DX and goodbye from Metrolina!

BILL COLEMAN telephones this info: WBAP-820 has an AN request line for your favorite c/w hits - call this toll-free number & get in a plug for NRC: 1-800-433-7606.

TONY'S GOT A NEW LIST OF CALL MEANINGS

TONY FITZHERBERT - 116 Devon Road - Chalfont, PA - 18914 9/7/81
 How nice to meet some of you at Rookaway - now I can connect the faces and names, and I hope that we have many more meetings like this! A surge of creativity from the rear booth at the banquet from PETE CLARIUS, JOE FELLA, DAVE SCHMIDT and others brings this continuation of call meanings: WFIF is Where Fun's In Fashion, WLBR was Lebanon Bible Radio, WLIM is Long Island Music, KFAX, once all news, symbolizes facts, T.L. Brown founded WTLB, WRNY serves Rome, N.Y., WTEL for an early owner's aspirations for television, WJSM is Where Jesus Saves Martinsbrug, WECK is for a roast beef sandwich (honest), WTAG for The Worcester Telegram And Gazette, WBBN for Buffalo Evening News, WAEB serves Allentown, Easton & Bethlehem, WBCB is Bucks County Broadcasting, WBAB - covered Babylon and Bay Shore, but, while in Atlantic City stood for Wonderful Beach and Boardwalk. (BAB always stood for Bare/---/Beach in my heyday, hi -ERC) Up North, VOWR was the Voice of Wesleyan Radio (Methodist Church) & VOOM is the Voice of the Common Man. Out West, KOAC for the Oregon Agricultural College, KVOO - Voice of Oklahoma Oil, and Down South, WSB "Welcome South, Brother". Remember experimental WEXR-1560? Well, the Q replaced 21 WESO serves Webster, Southbridge, WHOM's founder was Harry Omelia, WPAP for a New York landmark, Palisades Amusement Park, WMSG - Madison Square Garden, WERA - new ERA Radio (should have fooled me!). WPTF by an Insurance Company, "We Protect The Family", WAUI - American Insurance Union, WINS for the defunct International News Service, WNEW from a prehistoric merger into a new station. WVMR is West Virginia Mountain Radio. For the educated, WHCU is the Home of Cornell University. WSNY was in Schenectady, NY, now "Sunny" in Boston. CFQC Comes from Chatham, Ontario, and CFPL is for the Free Press-Leader. WGH is for the World's Greatest Harbor, WESL comes from East St. Louis, WPOE was Patchogue Order of Elks, now for Post's Rest (a mountain). WWDJ "We Watch Dear Jesus, KPCC - Pasadena Presbyterian Church, and WTAM was "Where The Artists Meet." WEMD covers Eastern MD, WTTM "World Takes, Trenton Makes, variation of a Chamber of Commerce theme, WJIC - Jersey Information Center. WFOG, for an occasional weather condition, WAMS "Wilmington's All Music Station", competitor WJBR was owned by John B. Reynolds, WGLI - Great Long Island, WGSN serves the World's Greatest Suburban Market. WITM "Love Them Mountains". Owner of WDRF also owned the Delaware River Ferry. WKEN serves Kent County, and WSUX, Sussex County! Finally, WNYN for Well, Now You Know! Hi. (WNYK?? -ERC) DX and Springfield Radio, next time! 73 from AKF.

DAVE'S ALL PLUGGED IN AND READY TO GO!

DAVE FOX - 333 Douglass Street - Reading, PA - 19601 9/10/81
 Basically a non-DX Summer ended with a very enjoyable NJ Convention. It was a great pleasure to meet a lot of fine people who enjoy and share our hobby. It was especially gratifying that some of our veteran DXers were willing to share and contribute many priceless memories of their DXing in a different era. It was also extremely interesting to read the DX collections of NORM MA-GUIRE and JOE BRAUNER. Several veries have arrived for August reports. They include WQQW-1590, WORC-1310, WMRC-1490, WXAM-1400 & CBI-1140. These raise the totals verified to 968. Total calls logged are just over 1400. Only recent report is off to WEEP-1080 for a 7:05-7:30pm logging on 9/10. The receivers are in good shape & I have my old Teac reel to reel repaired so I am all set for a good season. Hopefully we can get some CPC work done and put a couple of testers on the air - or merely announce a couple of PoP's from our locals. I intend to contact several locals. The radio scene in Reading is unchanged with WRAW-1340 NSP, WHUM-1240 w/a SM SP & WEEU-850 with a midnight s/off. Several final thoughts on the NJ Convention. I am not surprised that a WSRD sticker can be found on the safe from the Andrea Doria which now lies in the shark tank of the New York Aquarium! What I can't understand is the recent comment on a postcard from a Delaware DXer that I dined with two weird people at the banquet. Just who is calling whom weird? Finally, I have arranged with the special education department of my school district to have 400 kids send requests for SWL information to some P.O. Box in Pocknock, Conn.! Good DX and best 73's.

NIEL'S HAD A BUSY SUMMER WITHOUT DXING

NIEL WOLFISH - 75 Donwoods Grove - Toronto, ON - M4N 2K4 8/24/81
 The six week postal strike has finally ended, so I'm once again able to Muse. This Summer I've been busy working at my former high school's pool as a Swimming Instructor/Life Guard, & fill-in Acting Supervisor, plus I also write questions in my spare time for a CBC TV Quiz show. Hardly any DX-ing has been done, mostly because of better things to do. I hope to get going again in September. Time will be limited because of school. I'm beginning my first year in Arts & Sciences at University of Toronto. Today was former WLS DJ John Landecker's first day as AMD man w/CFTR. He didn't sound too exciting, so it looks like I'll continue to listen to CHEUM-AM or CILQ-FM in the mornings. I've never liked CFTR anyways. CJCL (ex-CKPH) has hired a few former DJ's from CFTR & CFRB, but they'll need more than that to bolster ratings. That's all for now. 73's. (Niel, who is the v/s for CJCL-1430? -ERC)

ERC DOESN'T KNOW THE DATE OF OUR NEXT MUSINGS DEADLINE, SO SEND 'EM IN PRONTO!

DAVE HAD SOME SUMMERTIME DX TO REPORT

DAVE SCHMIDT - 42 Chelwynne Road - Castle Hills - New Castle, DE - 19720 9/12
 There was shock brought to the fact of many who couldn't believe that I actually made it to the NJ NRC Convention this year. It was only through the good graces of luck and that week off from work that made it possible. Naturally it was good to meet the many who attended, meeting some for the first time and not seeing many for ten years! For those fortunate few who made it, they found out why DDXD really is the way it is! Anyone for a game of Hearts at LOUISVILLE? Since returning, the radio has actually been turned on, with a new switching box being built for piping audio to tape decks at hand.
 DX: 7/2- The new WVMR-1370 12:37-12:53am w/an ET of some TT/OC. 7/16- WLIM-1580 1:12-1:28am on an ET for a call change, ex-WYFA. 9/10- WMCT-1390 12:18-12:32am w/unlisted f/c-TT, w/IDs every 20 seconds! All of the notes and other stuff is in DDXD, I needed a little filler this month, hi! Veries: v/1 WVMR-1370, WLIM-1580, & WESB-1490. WESB is PA verie #147, keeping PA at 100% verified. Total: 1,063. I've noted a few comments made over deregulation by the FCC over many rules which cover stations on keeping logs, the elimination of the first class ticket, et al. Many stations will still maintain a daily program log, specifically for advertising reasons since, in many cases, this is the only proof that a paid commercial was actually aired. Thus if some advertisers say a station didn't air a certain commercial, the station will have ready proof that it was. And the CE as we know it will be the Chief Operator, who is in charge of the same duties as any CE. Many are scared this will have a bad effect on the DX hobby but I do not believe it will. It's just going to be a little more of an art in getting those prized veries! Keep at it, it's everyone who keeps the hobby going! 73's!

BRAD SENDS IN LOTS OF DX - WE LOVETT!

BRAD LOVETT - 421 East College Street - Coldwater, OH - 45828
 Fall weather has hit Ohio so we'll wrap up another Summer (short as it was here) and start another DX season on the BCB! I noted two occurrences of E-skip on FM only, one into Florida (it was good hearing some FL stations I heard when I was there) and one into Texas, but that's about it there. No tropo to speak of, just the usual Detroit, Cincinnati, Grand Rapids, Indianapolis and vicinity stuff. I have a few BCB loggings with some new stations of late, so I'll run through those quickly. 8/18- WTRU-1590, Mich., MI lottery numbers. On 8/15, I caught semi-local WTCY-1390 signing off late at 8:57pm in the middle of Ac NX, which I don't think they gold a contract for. (They're A1). 8/21- WRQT-1330, "My Sharons" (Hi, JERRY STARR) 8:48pm; WHBC-1480, 8:52pm "Your Good Neighbor"; WHIS-1440 Bluefield, WV, Cincinnati Reds, so strong I thought WPGW was on late, but did get a clear ID from WHIS. WKAZ-950 9:25pm w/ad for College Credit via Public TV-9. 8/22- WHGB-1360, ID as "1360 HGB". I'm calling this tentative, however, because I'm only 90% sure of this, 8pm. WFBG-1290 Altoona, 8:02pm w/PSA, WAWA-1590 W. Allis, WI, s/off 9:02pm, 8/23. Also 8/23, UnID on 1300, BFL format with pattern change at 9:15pm. 9/5 brought WNST-1600 WV @ 7:25pm w/WX from Huntington office of NWS, & WAAY-1550, Huntsville, AL. Local news: WHUT-1470, IN, drops CWM after a short time. Format is now adult contemporary with some CWM and Triple-Z jazz, NX on the hour. Fort Wayne continues to play Musical Networks. WOWO is now A1 & will carry Paul Harvey as soon as WQHK's contract with Ae runs out (10/5). WPTH-95.1 carried A1 for about a month, now they're Ac. WTCY/WTOO, Bellefontaine, OH, was victim of a strike a couple months ago. After late or "rubber" paychecks for several months, all the employees decided they'd had enough, setting up picket lines. Only the GM & OH remained to operate the place. After a day of tracking LPs, both of them also resigned. The owners then brought in reinforcements from co-owned WKTK, Lexington, KY, & a station they own near Nashville. Now they're still trying to rebuild the place. They were CWM on AM & Rock on FM, now they are simulcasting the FM format on both. As far as I know, some of the strikers are still walking the picket line. All for now. 73.

WARREN'S BEEN IN NOVA SCOTIA- AND NEW JERSEY

WARREN E. GREENBERG - 145 Cottage Road - West Roxbury, MA - 02132 August 27, '81
 By the time you read this the 1981 Convention in New Jersey will be history. Two new veries received, WADK & WMCA (after several reports). Totals for this year are 12 reported and six received. I was on vacation from Aug. 14 to 20 in Nova Scotia, Canada, and here is a bandscan from Mavillett Beach which is about 20 miles North of Yarmouth on the Gulf. The date was Aug. 18, 1981, and time was from 6 to 7pm, AST. WGAN, WEEL, WLBZ, WNBC, WRKO, WJTO, WHEB, WEAN, WEDH, WCBS, WABI, WZB, WITS. And on Aug. 19, from 5-7 pm AST, WCUY, WEZE, WTSN, WABK, WJDQ, WLOB, WLYN, WDEA, WBEX, WPLM, WNCB, WXKS, WJBQ, WFOR, WITS, WNTN. The receiver that was used was a Realistic TRF modified by Radio West with ceramic filters and a shotgun antenna. That's it. 73's.

COMING UP NEXT ISSUE IS OUR 49th YEAR OF THE NRC AND ITS GREAT PUBLICATION, "DX NEWS". LET'S SEE SOME MORE CONTRIBUTIONS FOR THIS SEMESTER - WHAT SAY? YOU NEW MEMBERS ARE MOST WELCOME TO MUSE - WE WANT TO MEET YOU IN THESE PAGES! AND ALL OUR FORMER REGULARS ARE MOST WELCOME TOO, OF COURSE - EVERYBODY PLAYS! I BELIEVE THE NEXT DEADLINE IS SATURDAY, OCTOBER 10 (Mon. Oct. 12 is a holiday).

WE WELCOME A NEW MEMBER WAY DOWN EAST

DAVID WHITE - Box 43 - Cherryfield, ME - 9 Sept. 1981
 My first letter since joining this outfit. I have been a listener for many years, since 1927, in fact, when I was eight years old. My dad who was a builder of such receivers as 'Diamond of the Air', built me a slide tuner crystal set with a carborundum crystal, & I have been at it ever since. I joined up with the USNR V-3 Communication Reserve in 1936, and went into the Navy and retired in 1960. I have been a Ham since 1934. Enough of the background, now to the present. MIKE TUGGLE sparked my late interest again in the crystal set, and I saw his article in the AWA magazine, and wrote to him. He responded with complete instructions for his Lynodyne set. Well, in the meantime I came across a book 'Radios that work for free', by K. E. Edwards, so I constructed the Telefunken design he had described. It works fine, and during the Summer when CX are not so good up here on the BCB, I was copying Washington, DC, New York, & Boston. And as far West as Pittsburgh and Buffalo. Canadians of course are in here loud also. Of course these stations are all 50kw. There are many stations in Maine that are difficult to hear at the present time, but with the Fall weather coming on and the change in seasons I can see the signals getting better. I aquired two olde tyme dials, and am in the process of rebuilding from breadboard model to a cabinet model receiver. I have a nice set of Brandes telephones to go with it. That is enough for now, thanks for letting me in wid a few words. 73. (Our pleasure, David - let'a hear more! -ERC)
 PS - WLBZ is now WACZ-620 (still 'Z-62').

CHICAGO IN THE OLD DAYS - WHEN THE CUBS WERE TOUGH!

GENE MARTIN - 3303 East Evans Avenue - Denver, CO - 80210 Sept. 10, 1981
 Before we close the book on Mothball Memories about Chicago, I would like to raise the question, "Who else remembers WOK in Homewood, Illinois?" This was a 5kw station on 217 meters, as we called it in those days, 1925-26-27, or 1380 if you prefer kilohertz. Five kilowatts was a lot of power in those days, and that portion of the BCB was terra incognita in those years, almost nothing else in the vicinity of 217 meters. So WOK had a loud signal and it could be picked up even on crystal sets for 600 to 800 miles. Homewood was a Chicago Suburb and I seem to recall WOK broadcast from Chicago studios, as well as dance bands from Chicago hotels. And there is one other memory which I retain about that station: in 1926, I believe, some radio publication carried a story about WOK's chief engineer being electrocuted one night after s/off while tidying up around the transmitter. It is my recollection now that WOK had disappeared by the Fall of 1928, and I do not know whether it merged with some other station or just gave up the ghost on its own. Another early Chicago station was WQJ, 500 watts, which always divided time with WMAQ on 447.5 meters. (All right, then, 670 kHz, for all you youngsters). WQJ was owned by the Calumet Baking Powder Co. and had a well-known announcer in those early days, Jerry Sullivan. WQJ was eventually swallowed up by WMAQ, which was a thousand watt owned by the Chicago Daily News. By 1932 WMAQ was owned by NBC and was a 5kw station. In the history of radio, there has been a lot of swallowing up over the years. Many of today's best known stations once divided time with some other station, then merged with it, and the other station ceased to exist. WJR swallowed up WCX in Pontiac, Mich. WGN took over WLIB on its frequency. WLS did the same with WENR which was the first 50kw station in Chicago. WBBM swallowed up WJBT and WIBO. WLAC merged with WDAD in Nashville. WABC in New York in 1932, the network key for CBS, took over WBOQ listed as Richmond Hill, NY. The present WABC used to be WJZ, BUT IT DROPPED THAT call practically overnight when CBS renounced WABC and became WCBS. Mothball Memories? I've got thousands of them. (Send 'em in, Gene - we can use them as space permits! -ERC)

PETE ENJOYED THE CONVENTION

PETE CLARIUS - 1583 Castleton Avenue - Staten Island, NY - 10302
 Just a few lines to say what a great time I had at the '81 Convention and once again thank RUSS EDMUNDS for a great time. It was very nice seeing such older members as DICK COOPER, CARLETON LORD, & of course my old buddy ERNIE COOPER. And also meeting new ones as MARK CONNELLY & RON MOSCO. But the turnout was too few for our membership. Thanks again.

WNYM'S ADDRESS IS THE SAME AS WPOW'S

HOWARD KEMP - 140 Court Street - Laconia, NH - 03246 9/9/81
 I don't know if you know it or not, but FCC in New York says WNYM address is same as WPOW, 1111 Woodrow Road - Staten Island, NY, 10312. WPOE, Greenfield, Mass. verified for me after five tries. CE signer was Jim Hemingway, on 7/24/81. Only additions this week were KCNC-560, R. Belize-834, and WRRO-1440. Hope it helps! (That it does, Howard - thank you! -ERC)

OLD WPME IS NOW NEW WPXZ

MARTY BRAUNER - R.D. 1 - Box 153 - Punxsutawney, PA - 15767 9/8/81
 Hi! I want to report that WPME-1540, Punxsutawney, changed to WPXZ on Labor Day. (Thank you, Marty! - for those of you who don't know, Marty (Martha) is JOE BRAUNER'S widow - a wonderful lady. ETC)
 AS THEY SAY OF THE CONVENTION IN ZAREPHATH, "WAWZ-1380" - "WHAT A WONDERFUL ZINGER!"

ERNEST R. COOPER - 5 Gray Street - Provincetown, MA - 02657 617-487-9337
 As many have said, "The 1981 NRC Convention is now history." I don't know what history book you'll find it in, but, never-the-less, it's history! And it was a jolly good one, too, and it was really great meeting several NRCers never before encountered, but especially gratifying was meeting with my old friend DICK COOPER (no relation) once again, after 1 1/2 decades! I wonder what happened to the expected bid for Tampa as 1982 Convention Site by JEFF LOCKWOOD, who didn't show? I missed my friend FRANK MERRILL this year, & the rest of the fun-loving Toledo contingent! Frank had a nasty flood in his basement, I hear, which prevented him from attending. The Convention banquet was exquisite - by far, the best Convention meal in years! Those mussels as appetizer were sensational! The beer was the finest, too, so well done, RUSS EDMUNDS and BOB STONIER - Thank You! Maybe at next year's LOUISVILLE outing I'll finally get to see Churchill Downs, after two visits to that city without making the trip schedule (The bus left too early!) On my way back home, I paid a visit to ex-NRCer Bill Wurtzel who says hello to all his all friends in NRC, and he says he still would appreciate hearing from you-uns at 32 West 31 Street, NY, NY, 10001. He seems to have more radios than New York has stations! Well, the HQ-180 has been outfitted with five new tubes, and is all set to pick up some new ones. I had had a Duracell alkaline 9-volt battery in my SM-2, used with this set, and I was having overload problems in several areas of the dial. I solved the problem by removing it and substituting a Radio Shack Energcell, and now things are working fine. Has anyone else found trouble with the Duracell? The R-390A/URR, by Motorola, is currently being checked for weak tubes, so all DXing is being done on the Hammarlund while the R-390 rests. DX: MM 8/10- UnID TTer 2-2:15 on 1400 o/a Larry King repeat. Unn WHMP noted in there too, so they're AN MMs, they announced 1400 & FM-99, so they're simulcasting, too. Does any other New Englander notice a fairly strong OC on 1450 EVERY morning after 1 like I do, and does anyone know who it is? Unns noted today were WJLK-1310, WIRK-1290, WLQY-1320 & WMAS-1450, all ANing. KGAK-1330 joins the L.King thing. 8/12- UnID TTer on 1230 1:05. WPTB-1540 was off this AM, also WBBX-1380, both were back 8/13 tho. Also on 8/13, TT on 740 1:15, gone at 1:19. MM 8/17 was very noisy & a nothing morn. 8/22- UnID TTer on 960 2-2:10, looped toward PA, I'm wondering if 'twas WPCN, per chance? 8/25- C.R.B.-1610 s/off @ 1:17. And I heard ex-NRCer KenMaylath doing the 2am NX on WFBR-1300. 9/1- TT-1450 1:22-1:30, no IDs caught. WTOP-1500 was off today and every day this week, yet they are the flagship station for El King! What gives? SM 9/13- After checking several AMs, I am convinced CKCW-1220 is about a half-kilocycle off frequency on the low side - anybody concur? The CBC AN network stuff seems over! C U soon.

IRCA PUBLICATIONS OFFER

The NRC and the IRCA Goodie Factory have agreed to swap member discounts on all merchandise available through both clubs. This means that NRCers can now buy IRCA merchandise at the same price that IRCA members can. Below you will find a complete list.

IRCA Foreign Logs: These handy references contain a complete year of foreign DX as reported to IRCA's World Wide columns. Other features include articles on how to hear and identify stations, BCB propagation, country reports and station lists.

Volumes 3('73-'74), 4('74-'75) and 6('76-'77): \$2.00 each (close out special)
 Volume 5('75-'76) (only four left): \$4.00 (\$4.50 to non-IRCA/NRC members)
 Volume 7('77-'78) and 8('78-'79): \$4.50 (\$5.00 to non-IRCA/NRC members)

Volume 9('79-81) will be out sometime in the late summer of 1981. Price approx \$5-6.

IRCA Almanac: This highly successful IRCA publication is in its second edition. It includes the current frequency check list, sunrise/sunset maps for the US and the world, list of radio network, syndicated and religious program affiliates, station slogans, AM-FM simulcasters, sport programs, utility stations, a glossary of DX terms and articles on AM broadcasting. This handy cross reference to the NRC Domestic Log is a must for the serious BCB DXer. 164 pages and comb bound.

Volume II of the IRCA Almanac is priced at: \$5.50 (\$6.50 to non-IRCA/NRC members)

A DXers Technical Guide: Our latest new publication, this 100 page book includes articles on receiver and antenna theory, receiver reviews and modifications, antenna design and construction, hints on how to build and use receiving accessories, and more.

The Technical Guide is available for: \$4.50 (\$5.00 to non-IRCA/NRC members)

The IRCA offers a list of over 450 pages of reprints of articles from past issues of DX Monitor (our 34 times a year bulletin). Current price is 9¢ per page for first class delivery. Topics covered are antenna design and construction, domestic DX, foreign DX, DXing techniques, radio history, receiver reviews, modification, design and accessories, propagation and other technical topics.

A complete list of reprints can be yours for a SASE.

All the above items can be purchased from: IRCA Goodie Factory
 P.O. Box 17088
 Seattle, WA 98107

Don't forget to mention that you're an NRC member to be eligible for the discounts. Overseas members add \$1.00 per book. Please allow six weeks for delivery.

VERIFICATION GAME

WAYNE HEINEN
 427 E. CARAMILLO ST.
 COLORADO SPRINGS, CO 80907
 (303) 632-3332

From usually Sunny but lately Stormy Colorado comes another Veri-Game column. As promised the results of the survey on how various DX'ers count the number of stations verified.

Question #1 Would you start a new verification count if you were to move? This went about 60% YES and 40% no. Most qualified there answer with a mileage figure between 25 and 100 miles. Most in favor of starting over with a new count signified that they would probably not re verify easy to hear stations or clears, just rarer DX catches.

Question #2 Do you count call letter changes? This question also ran 60% Yes and 40% no. The groups were the "allocation" counters and the call letter counters. Those who count allocations (ie 920 kHz Providence RI) would only verify one set of calls for the channel in that city. This count would differ from those who identify by Call letters who would have two sets of calls on this allocation.

Question #3 Would you count a frequency change as a new station? This ran 85% yes and 15% no. Yes answers generally felt that the switch would represent an entirely new set of DX'ing conditions and there by making the station reception possibility different than the earlier logging. The majority of the allocation counters said yes, about half the call letter counters said yes, and the remainder of the call letter counters said they would if the switch involved a call letter change.

Question #4 Would you count a change in location similar to KRGO switch from Salt Lake to Granger Utah? 3% Yes and 97% NO. It was agreed that this kind of switch was mostly a formality to allow a change of facilities.

Question #5 Would you count a re-issued call (ie WRYT, Pittsburgh and WRYT, Boston) This question came out about the same as number two. The call letter group felt that the other changes surrounding the re-issued call was sufficient to call it a new station. The allocation group qualified there answers by saying it would need to be the first time they had heard the particular allocation.

Question #6 Would you count changes in facilities? 3% Yes and 97% No. Kermit Geary's answer summed up the feeling of most DX'ers on this " No, life is complicated enough as it is"

I draw no conclusions from this survey. There would appear to be the two main schools of thought in counting verifications and loggings for totals heard/verified. As with the make up of the NRC the individual variations are many as BCB DX'ing is truly an individualistic hobby.

Now a contribution with some hints and opinions from a veteran DX'er and dedicated verifier of BCB DX catches. I will turn the editorial Soap Box over to Kermit Geary of Walnutport, PA

" I don't believe I can add anything to the art of reporting and verie collecting that has not already been said. While I have received many compliments on the completeness and quality of my reports, I find that my holdouts are the same as everyone else's and that some stations will just not reply, even with a prepared card. Also, a verie will frequently be reported by someone from a station that has failed to reply to me. In many instances, it is just a matter of luck in hitting the station at a time when somebody is in the proper mood and has time to reply. In general, the rules of reporting include the following: Neatness and honesty are prime requisites, organize your report; be concise and orderly, Report what you heard as completely and clearly as possible, Include as many distinctive and identifiable items as possible, let the station know you were glad to hear them, Never demand a verie; but definately request it; indicating how pleased you would be to receive a reply, ALWAYS INCLUDE RETURN POSTAGE.

In reporting program details that are easily verified, the most preferred items are commercials, distinctive announcements such as contests, promos etc. announcers names... if none of these are heard, the inclusion of a tape provides a very significant proof of reception because the announcer will be easily recognized by the station. Do not request the return of your tape. Instead send a 7 1/2 i.p.s. copy of your original recording. I was advised by one CE that playing 3 3/4 i.p.s. tape can be a problem at some stations because their equipment operates at 7 1/2 i.p.s.

